



EZ-SCREEN™ Grid

Instruction Manual

EZ-SCREEN Features

- Non-contact safety device for perimeter and access guarding from dangerous machinery
- Diverse-redundant and self-checking design to achieve control reliability and meet IEC 61496-1 type 4 requirements
- Choose models with 2, 3, or 4 beams, beam spacing from 300 to 584 mm (12" to 23")
- Self-contained two-part system is optically synchronized:
 - Needs no external controller
 - Needs no extra synchronization wire
 - Easy and economical to install
- Operating range 0.8 to 20 m or 15 to 70 m (2.6' to 65' or 49' to 230')
- Selectable external device monitoring
- Selectable trip or latch output
- Fast 24 millisecond output response time for all models
- Easy-to-use removable terminal blocks or quick-disconnect options speed and simplify wiring
- Compact, robust housing
- Multiple mounting options
- Optional accessory interface module available for ac or larger dc loads
- Configuration settings accessible from the front, with supplied tool. Sensor settings can be changed while sensor remains mounted.



Section Contents

Section 1	Introduction Overview	Page 4
Section 2	System Components and Specifications	Page 10
Section 3	Installation and Alignment	Page 16
Section 4	System Operation	Page 40
Section 5	Troubleshooting and Maintenance	Page 45
Section 6	Periodic Checkout Procedures	Page 51



the machine safety specialist

9714 10th Avenue North • Minneapolis, MN 55441
Phone: 763.544.3164 • <http://www.bannerengineering.com>
Email: sensors@bannerengineering.com

Appropriate Applications

The Banner EZ-SCREEN Grid System may be used in access-guarding and perimeter-guarding applications only with machinery that can be stopped immediately after a stop signal is issued. It may be used with part-revolution clutched machines that have the ability to stop at any point in their stroke.

Under no circumstances may the EZ-SCREEN Grid System be used to guard full-revolution clutched machinery. The Banner EZ-SCREEN Grid Systems may not be used as tripping devices to initiate machine motion (PSDI applications) on mechanical power presses, per OSHA regulation 29 CFR 1910.217.

The Banner EZ-SCREEN Grid System is typically used in access-guarding or perimeter-guarding applications for the following types of machines:

- Assembly stations
- Manufacturing cells
- Automated production equipment
- Robotic work cells

The Banner EZ-SCREEN Grid System may not be used in the following types of applications:

- For hand or finger detection in point-of-operation guarding (see Section 3.1)
- In non-vertical area-guarding applications
- To guard any machine that cannot be stopped immediately after a stop signal is issued, such as single-stroke (or “full-revolution”) clutched machinery
- To guard any machine with inadequate or inconsistent machine response time and stopping performance
- To guard any machine that ejects materials or component parts through the light grid
- In any environment that is likely to adversely affect photoelectric sensing system efficiency. For example, corrosive chemicals or fluids or unusually severe levels of smoke or dust, if not controlled, may degrade the efficiency of the safety light grid

Important ... read this page before proceeding!

In the United States, the functions that Banner EZ-SCREEN™ Systems are intended to perform are regulated by the Occupational Safety and Health Administration (OSHA). However, whether or not any particular EZ-SCREEN System installation meets all applicable OSHA requirements depends upon factors that are beyond the control of Banner Engineering Corp. These factors include the details of how the EZ-SCREEN System is applied, installed, wired, operated, and maintained.

Banner Engineering Corp. has attempted to provide complete application, installation, operation, and maintenance instructions. In addition, we suggest that any questions regarding application or use of EZ-SCREEN Systems be directed to the factory applications department at the telephone number or addresses shown at the bottom of this page.

Banner EZ-SCREEN Systems can guard against accidents only when they are properly installed and integrated into the machine, properly operated, and properly maintained. See Section 3 of this manual for installation procedures, considerations, and precautions. See Sections 4 and 5 for operating and maintenance information. **It is the responsibility of the purchaser and/or user to apply this EZ-SCREEN System in full compliance with OSHA regulations.**

In addition to OSHA regulations, several other organizations provide informational material on the use of machine guard devices. The user is referred to the American National Standards Institute (ANSI), the Robotics Industries Association (RIA), the Association for Manufacturing Technology (AMT), and others. Banner Engineering Corp. makes no claim regarding a specific recommendation of any organization, the accuracy or effectiveness of any information provided, or the appropriateness of the provided information for a specific application.

The user has the responsibility to ensure that all local, state, and national laws, rules, codes, and regulations relating to the use of this machine guarding system in any particular application are satisfied. Extreme care is urged to ensure that all legal requirements have been met and that all installation and maintenance instructions contained in this manual are followed.

Caution!!

Banner EZ-SCREEN Systems are for use only on machinery that can be stopped immediately after a stop signal is issued. They may be used with part-revolution clutched machines that have the ability to stop at any point in their stroke. **Under no circumstances may the EZ-SCREEN System be used on full-revolution clutched machinery.** Banner EZ-SCREEN Systems may not be used as tripping devices to initiate machine motion (PSDI applications) on mechanical power presses, per OSHA regulation 29 CFR 1910.217.

U.S. Standards Applicable to Use of EZ-SCREEN™ Systems	
ANSI B11 Standards	<i>Safeguarding of Machine Tools</i>
ANSI/RIA R15.06	<i>Safety Requirements for Robot Systems</i>
NFPA 79	<i>Electrical Standard for Industrial Machinery</i>
See pages 62 and 63 for information on these and other applicable standards, and where to acquire copies.	

Banner Engineering Corp.
9714 - 10th Avenue No.
Minneapolis, MN 55441
Email: sensors@bannerengineering.com

Table of Contents

1. Introduction — Overview	page 4	5. Troubleshooting and Maintenance	Page 45
1.1 System Description	4	5.1 Troubleshooting Lockout Conditions	45
1.2 Applications and Limitations	6	5.1.1 Receiver Error Codes	46
1.3 Control reliability	8	5.1.2 Emitter Error Codes	48
1.4 Operating features	8	5.2 Electrical and Optical Noise	49
2. System Components and Specifications	Page 10	5.3 Test Mode	50
2.1 Models Available	10	5.4 Servicing and Maintenance	50
2.2 Accessories	10	6. Checkout Procedures	Page 51
2.3 Replacement parts	12	6.1 Schedule of Checkouts	51
2.4 Literature	12	6.2 Trip Test	51
2.5 Specifications	13	6.3 Commissioning Checkout	53
2.6 Dimensions	15	6.4 Daily Checkout	55
3. Installation and Alignment	Page 16	6.5 Semi-Annual Checkout	56
3.1 Appropriate applications	16	Appendix –	
3.2 Security Protocol	17	QD Models	Page 57
3.3 Mechanical Installation Considerations	18	QD Model Accessories	Page 58
3.3.1 Minimum Separation Distance (D_S)	18	Accessory Bracket Dimensions	Page 59
3.3.2 Supplemental Safeguarding	21	Glossary of Safety Terms	Page 60
3.3.3 Emitter/Receiver Orientation	22	Safety Standards	Page 62
3.3.4 Adjacent Reflective Surfaces	23		
3.3.5 Use of Corner Mirrors	24		
3.3.6 Avoiding Electrical and Optical Noise	25		
3.3.7 Multiple-System Applications	25		
3.4 Mechanical Mounting Procedure	26		
3.5 Electrical Connections	28		
3.6 Light Grid Initial Checkout and Optical Alignment Procedure	30		
3.7 Electrical Interface to the Guarded Machine (Permanent Hookup)	33		
3.7.1 OSSD Output Connections	33		
3.7.2 FSD Interfacing Connections	33		
3.7.3 Machine Primary Control Elements and EDM Inputs	35		
3.7.4 Remote Test Input	36		
3.8 Preparing for System Operation	36		
4. System Operation	Page 40		
4.1 System Configuration Settings	40		
4.2 Reset Procedures	41		
4.2.1 Receiver Resets	41		
4.2.2 Emitter Resets	41		
4.3 Status Indicators	41		
4.4 Normal Operation	43		
4.5 Periodic Checkout Requirements	44		

1. Introduction — Overview

1.1 System Description

The Banner EZ-SCREEN™ Grid System is an optically synchronized, microprocessor-controlled, opposed-mode optoelectronic “light grid.” This economical two-part system consists of an emitter and receiver. The system requires no external controller or sync wire between the emitter and receiver; the microprocessors are located within the receiver. The receiver has two solid-state safety outputs to control 24V dc loads. If an ac-powered MPCE or other load is required, an accessory interface module may be used to convert the EZ-SCREEN dc outputs to isolated, forced-guided relay contacts. (See Section 2.2 and Figures 3-17 and 3-18 for more information.)

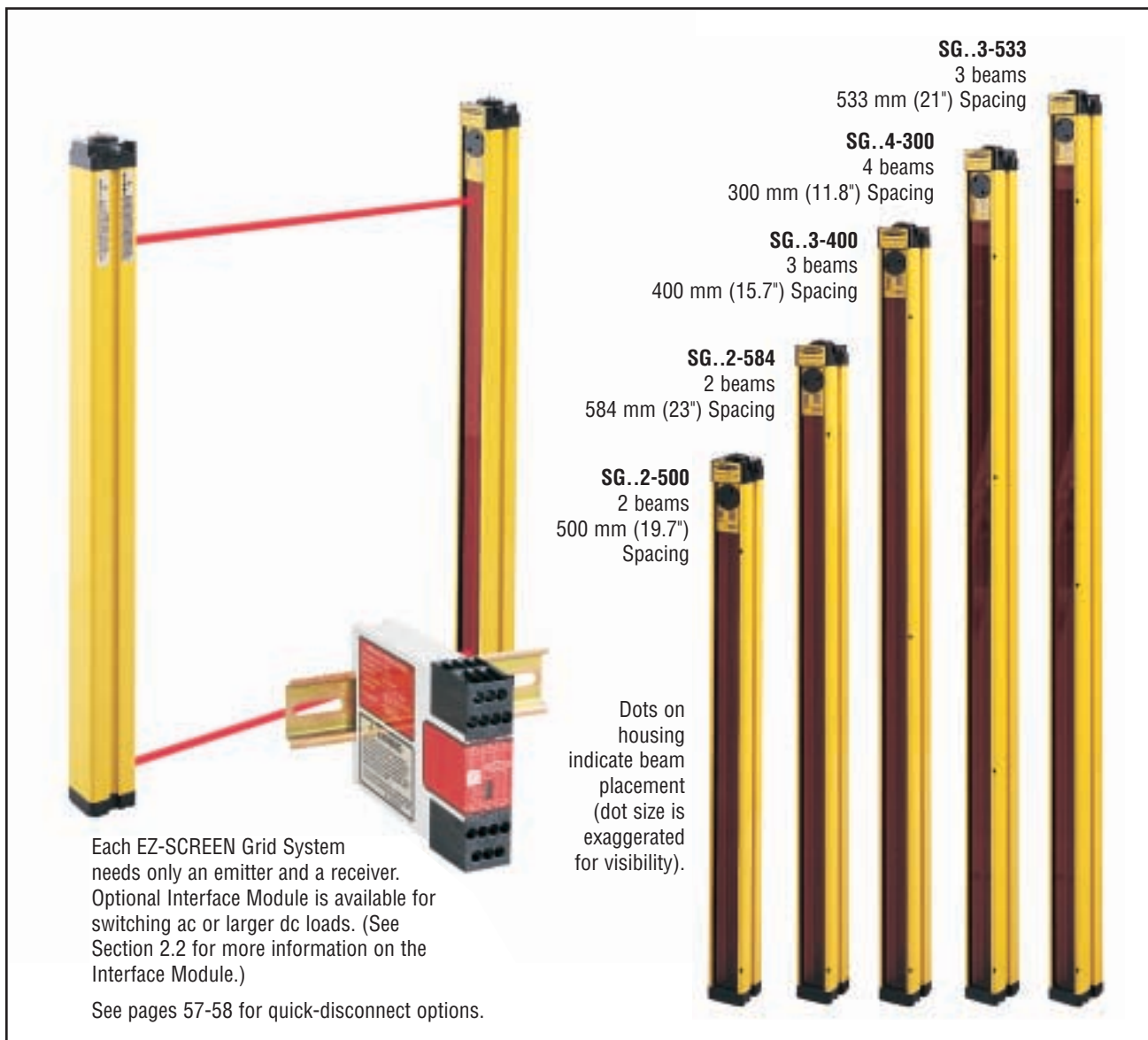

Figure 1-1. EZ-SCREEN Models

Five sensor configurations are available, with two, three or four beams; emitters have short-range and long-range versions. (Receivers are the same for both long-range and short-range operation.) Beam spacing ranges from 300 mm to 584 mm (12" to 23"), depending on the model. The configuration (the overall length and beam spacing) required for an application is determined by the application and the safety standards being followed. Models SG..E/R2-584 and SG..E/R3-533 are based on recommendations in ANSI/RIA R15.06 and ANSI B11 standards. Models SG..E/R4-300, SG..E/R3-400, and SG..E/R2-500 are based on recommendations in EN 999. See pages 60 and 61 for a list of applicable safety standards. Emitters and receivers do not need matching serial numbers to work together; any emitter may be used with any receiver of the same length and beam configuration. Figure 1-1 shows the sizes and beam configurations of the models available.

The emitter/receiver beams feature a narrow effective aperture angle (EAA) for effective long-range sensing — up to 70 meters, depending on model. The EAA satisfies IEC 61496-2 (type 4), including requirements for extraneous reflections and misalignment.

Cabling is accomplished in one of two ways. User-supplied cable may be hard-wired into the emitter and receiver housings, using the removable terminals in the end cap of each sensor, or Mini-style quick-disconnect models are available for easier installation; see pages 57-58. See Section 2.5 for cable specifications and Section 3.7 for wiring instructions.

Banner EZ-SCREEN Grid components may be purchased individually or in kits. Kits include one emitter, one receiver, a keyed reset switch, and standard mounting hardware for both sensors. When purchased separately, the emitter and receiver each include one cable gland, mounting hardware for one sensor, plus the accessory spanner wrench. The Key Reset switch also is available separately, or the user may provide other means to reset the system (see specifications in Section 2.5 for switch requirements).

The OSSD (solid-state safety outputs) are capable of performing a “handshake” communication with the Muteable Safety Stop Interface (MSSI) or Universal Safety Stop Interface (USSI) that are found on other Banner Engineering safety products. The handshake protocol is satisfied by any Banner Engineering Safety Category 4 (per ISO 13849-1/EN954-1) device with OSSD outputs or MSSI/USSI inputs.

To ensure a Safety Category 4 (per ISO 13849-1/EN954-1) interface between the two devices, the MSSI/USSI provides a “handshake request” that Banner Engineering safety devices with OSSD solid-state outputs are capable of responding to. This handshake verifies that the interface between the two devices is capable of detecting certain unsafe failures that may occur, such as a short-circuit to a secondary source of power or to the other channel, high input resistance or loss of signal ground.

1.2 Applications and Limitations

The Banner EZ-SCREEN Grid System is designed for use in access-guarding and perimeter-guarding applications. It is designed to be mounted vertically, in order to detect a body or torso (rather than a hand or an arm) as a person enters a hazardous area. It is not intended nor designed for hand or finger detection in point-of-operation guarding or for area-guarding applications.

In perimeter-guarding and access-guarding applications, the light grid is vertical or nearly vertical. In these applications, personnel typically can pass through the light grid (which removes or stops the hazard), then may continue into the hazardous area.

A recommended set of beam placement positions has become accepted in the United States and Europe. The standards (ANSI/RIA R15.06, ANSI B11 and EN 999) recommend a safe beam placement, in order to hinder personnel from crawling over, under or through the light grid, and into the hazardous area, without detection. For more information, refer to Section 3.3.1.

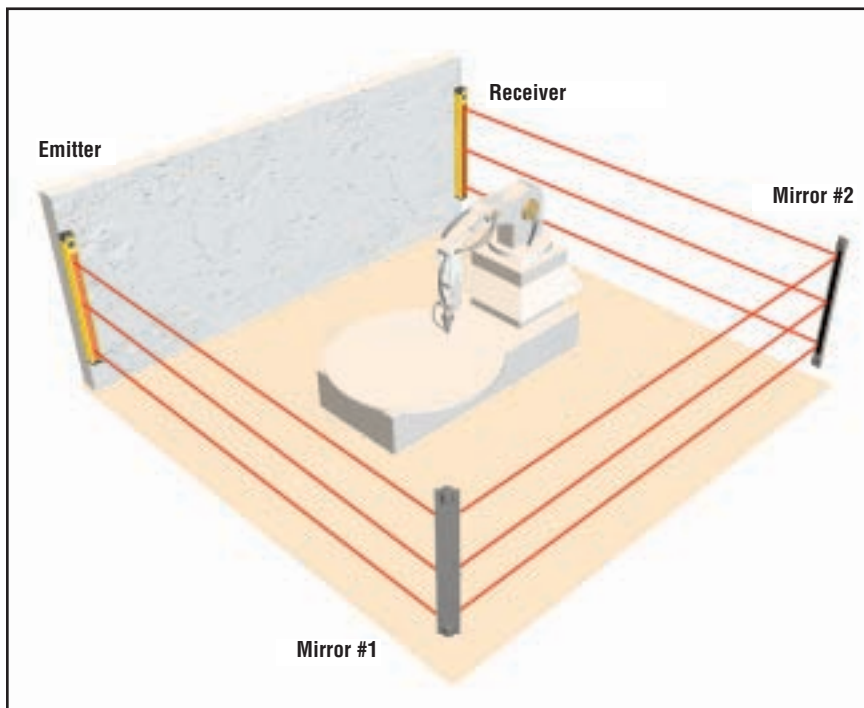

Figure 1-2. EZ-SCREEN perimeter-guarding application

WARNING . . .
Not for Point-of-Operation or Area Guarding

Do not use the EZ-SCREEN Grid System for point-of-operation or non-vertical area guarding.

CAUTION . . .
Proper Model Selection

Ensure proper selection of emitter models, with respect to range (operating distance) between emitter and receiver, to minimize the possibility of optical short circuits (see Sections 2.1 and 3.3.4).

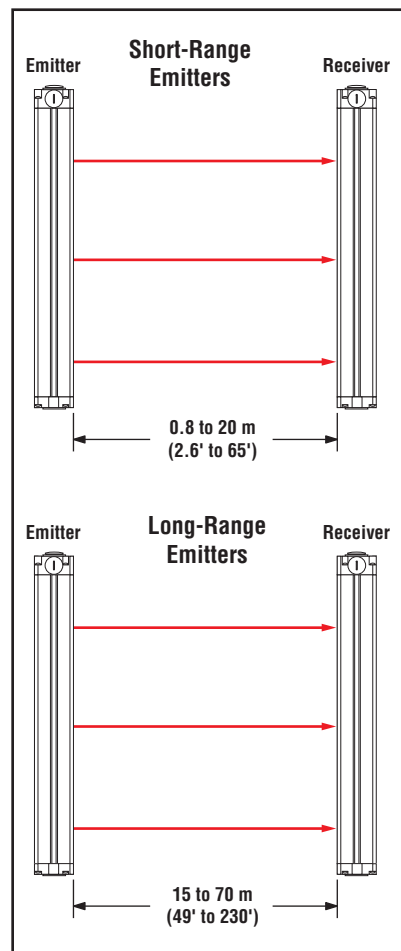

Figure 1-3. Selecting the proper emitter



WARNING . . .
Use of Trip Output

Application of power to the EZ-SCREEN

Grid System **MUST NOT** initiate dangerous machine motion.

Machine control circuitry must be designed so that one or more initiation devices must be engaged (i.e. a conscious act) to start the machine in addition to the EZ-SCREEN Grid System going into RUN mode.

Failure to follow these instructions could result in serious bodily injury or death.



CAUTION . . .
Other Applications

For applications not covered in this manual, contact a factory applications engineer before installing or using the EZ-SCREEN System.

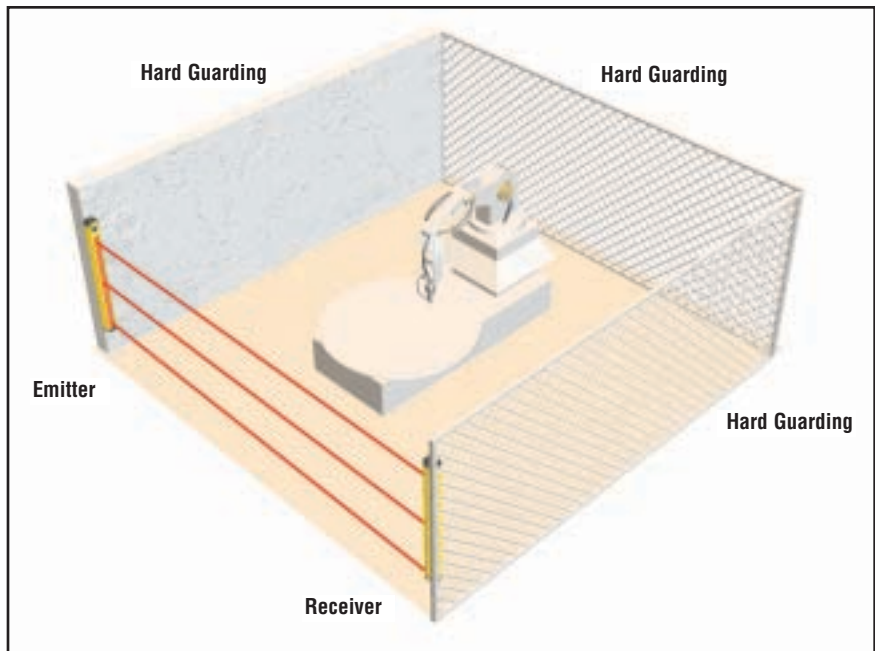

Figure 1-4. EZ-SCREEN access-guarding application

Pass-through hazards: Perimeter- and access-guarding applications must be designed to prevent *pass-through hazards*. A pass-through hazard occurs when an individual is allowed to cross the safeguard (which issues a stop command to remove the hazard). Subsequently, the person may cross into the hazardous area but their presence is no longer detected. A danger arises because the machine's dangerous motion may resume while personnel are within the safeguarded area. Several measures can be taken to prevent a pass-through hazard, which include, but are not limited to:

- A latching output on the safety light grid guarding the access or perimeter to the hazardous area, which requires a manual reset procedure before machine motion can be re-initiated. The reset switch has several requirements, including its placement outside of the guarded area, and out of reach of anyone inside the guarded area. In addition, the reset switch operator must have full view of the entire guarded area during the reset procedure.
- Supplemental safeguarding, such as described by the ANSI B11 series of safety requirements or other appropriate standards, to prevent personnel from standing undetected within the guarded area.

In addition, hard guarding should be installed around the hazardous area to prevent personnel from entering the guarded area, undetected by the safety light grid, or other safeguarding means.

Because the EZ-SCREEN Grid has a selectable (latch or trip) output, it must be installed and configured to prevent hazardous motion from occurring while personnel are within the guarded area. See Section 4.1 for more information.

EZ-SCREEN Grid may be used to guard many types of machines, including those for packaging, palletizers, roll formers and many types of work cells, including robot cells. The guarded machine(s) must be capable of stopping at any point in their motion; see page 2 for a complete list of requirements for machines that may be guarded by this system.

1.3 Control Reliability

In addition to physical location requirements, safety standards require a safety system such as the EZ-SCREEN Grid to fulfill some internal requirements. For example, for an optical safety system to be used in a Safety Category 4 application (per ISO 13849-1/EN954-1), it must be third-party certified to the type 4 requirements of IEC 61496-1 and -2.

EZ-SCREEN Grid’s microprocessor-based circuitry features a “diverse-redundant” design, in which two microprocessors of different design, running from different instruction sets, constantly check all system components, including each other. In addition, EZ-SCREEN Grid is extensively FMEA (Failure Mode and Effects Analysis) tested to establish an extremely high probability that *no system component will ever* (even if it does fail) *cause a failure to danger*.

1.4 EZ-SCREEN Grid Operating Features

The Banner EZ-SCREEN Grid System features several selectable functions: trip or latch output, external device monitoring (EDM), and scan code setting. These settings are configured within the sensors, behind the threaded access port on the front of each sensor and in the sensor wiring configuration; see Section 4.1 for more information.

Selectable Trip/Latch Output

The setting for latch or trip output also determines whether the System will enter Run mode automatically or require a manual reset (see Section 4.1). If the system is set for trip output, other measures must be taken to prevent a pass-through hazard; see Section 3.3.2 for more information.

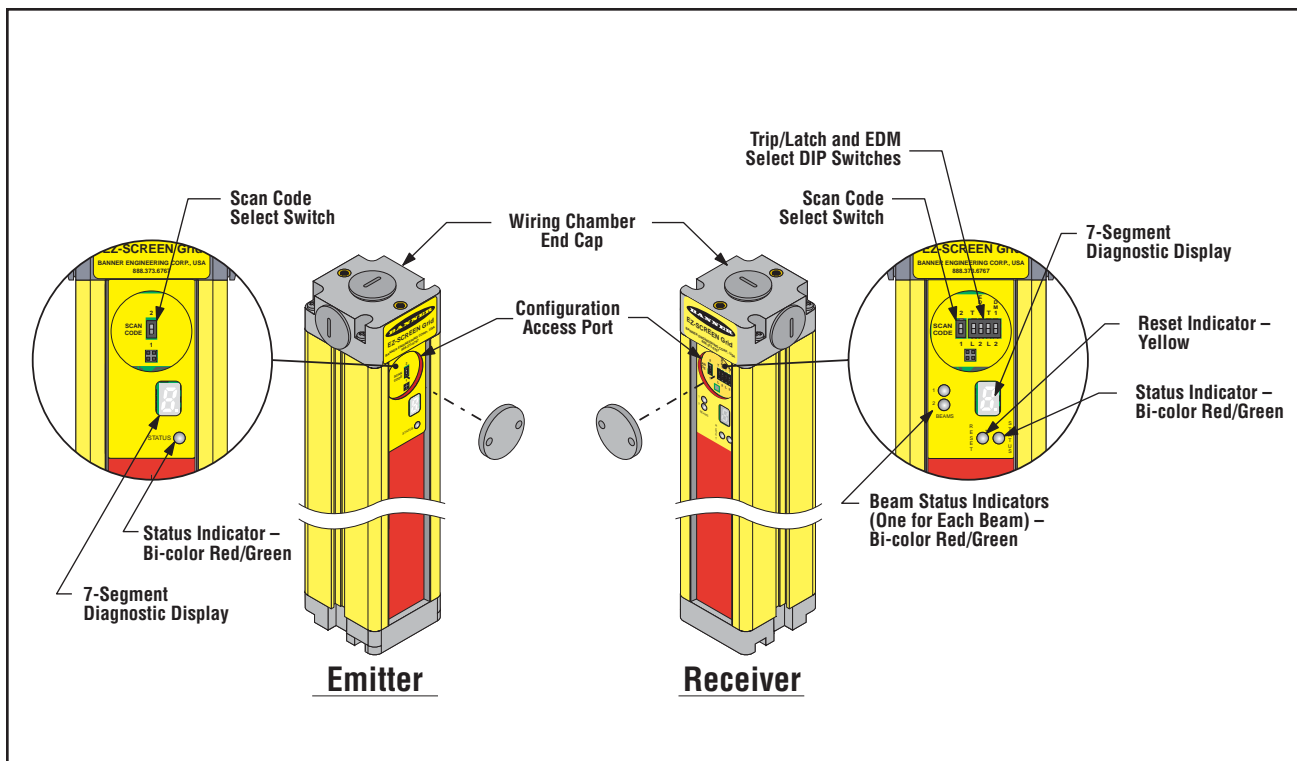

Figure 1-5. EZ-SCREEN features

If trip output is selected, the OSSD outputs will turn ON after power is applied, and the receiver passes its internal self-test/synchronization and recognizes that all beams are clear. The trip output will also automatically reset after all interruptions of one or more beams are cleared. If latch output is selected, the EZ-SCREEN requires a manual reset for the OSSD outputs to turn ON, after power is applied and all beams are clear (see Section 4.2.1).

External Device Monitoring (EDM)

This feature allows the EZ-SCREEN Grid to monitor the status of external devices, such as MPCs. The choices are one- or two-channel monitoring, or OFF. EDM is used when the EZ-SCREEN Grid OSSD outputs directly control the energizing and de-energizing of the MPCs or other external devices; see Sections 3.7.3 and 4.1 for more information.

Remote Test Input

A pair of terminals is provided at the emitter (see Section 3.7.4) for an external switch, typically a normally open contact held closed. Opening a switch connected between these two terminals “turns off” the emitter, simulating an interruption of one or more light beams. This remote test input may be useful for EZ-SCREEN Grid system setup and to verify machine control circuit operation.

Scan Code Configuration

The emitter and receiver may be configured to one of two scan code positions (1 or 2). Scan codes enable a receiver to recognize beams only from an emitter with the same scan code setting. This helps minimize the effects of crosstalk between multiple emitter/receiver pairs, and allows multiple pairs to operate in close proximity in certain situations. See Section 3.3 for proper mounting configurations. The scan code is set using the selection switch in each sensor’s configuration port; see Section 4.1 for more information. Both the emitter and its corresponding receiver must be set to the identical setting.

Status Indicators

A variety of status indicators on both the system emitter and receiver are clearly visible on each sensor’s front panel.

- **Emitter:** A single bi-color red/green Status indicator shows whether power is applied, and whether the emitter is in Run mode, Test mode, or Lockout mode. A 7-segment diagnostic display indicates specific error or configuration conditions.
- **Receiver:** A bi-color red/green Beam Status indicator for each beam shows whether that beam is aligned and clear with a strong signal, clear but with a weak signal, or is blocked and/or misaligned. A yellow Reset indicator shows when the system is in Run mode or is waiting for a reset. A bi-color red/green Status indicator shows when outputs are ON or OFF, or the system is in Lockout mode. A 7-segment diagnostic display indicates specific error or configuration conditions.

See Section 4.3 for more information about specific indicator and diagnostic display code meanings.

2. System Components and Specifications

2.1 Models Available

Banner EZ-SCREEN Grid components may be purchased individually or in kits. Kits (as indicated below) include one emitter, one receiver, a keyed reset switch, two cable glands, two spanner wrenches, a test piece, and standard mounting hardware for both sensors. When purchased separately, the emitter and receiver each include mounting hardware for one sensor, one cable gland, a test piece, and a spanner wrench. Keyed reset switches are also available separately.



CAUTION . . . Proper Model Selection

Ensure proper selection of emitter models, with respect to range (operating distance) between emitter and receiver, to minimize the possibility of optical short circuits (see Section 3.3.4).

Short-Range Models* (0.8 m - 20 m)	Long-Range Models* (15 m - 70 m)	Overall Length	Number of Beams	Beam Spacing	Protected Height	Application Standard
SGE2-584 Emitter SGR2-584 Receiver SGP2-584 Kit	SGXLE2-584 Emitter SGR2-584 Receiver SGXLP2-584 Kit	768 mm (30.2")	2	584 mm (23")	584 mm (23")	ANSI/RIA R15.06 ANSI B11
SGE3-533 Emitter SGR3-533 Receiver SGP3-533 Kit	SGXLE3-533 Emitter SGR3-533 Receiver SGXLP3-533 Kit	1251 mm (49.3")	3	533 mm (21")	1066 mm (42")	ANSI/RIA R15.06 ANSI B11
SGE2-500 Emitter SGR2-500 Receiver SGP2-500 Kit	SGXLE2-500 Emitter SGR2-500 Receiver SGXLP2-500 Kit	684 mm (26.9")	2	500 mm (19.7")	500 mm (19.7")	EN 999
SGE3-400 Emitter SGR3-400 Receiver SGP3-400 Kit	SGXLE3-400 Emitter SGR3-400 Receiver SGXLP3-400 Kit	984 mm (38.7")	3	400 mm (15.7")	800 mm (31.5")	EN 999
SGE4-300 Emitter SGR4-300 Receiver SGP4-300 Kit	SGXLE4-300 Emitter SGR4-300 Receiver SGXLP4-300 Kit	1084 mm (42.7")	4	300 mm (11.8")	900 mm (35.4")	EN 999 ANSI/RIA R15.06 ANSI B11

* Hard-wired models only are listed. Add the suffixes listed below for quick-disconnect models; see pages 57-58 for more information.

Emitter suffix Q3: 3-pin Mini-style QD, Test input jumpered

Emitter suffix Q5: 5-pin Mini-style QD, Test input available

Receiver suffix Q8: 8-pin Mini-style QD

2.2 Accessories

LAT-1	52150	Laser Alignment Tool with adapter clip
EZA-LAT-1	66027	Clip-on retroreflective target
BRT-THG-2-100	26620	50 mm (2") wide reflective tape, 2.5 m (100") long
BT-1	26809	Beam Tracker
SI-QS-CG13	48564	Pg13.5 cable gland
SI-QM-13	48559	Adapter, 1/2" NPT to Pg13.5
SI-QM-13-M20	66579	Adapter, M20 to Pg13.5
IM-T-9A	61425	Interface Module (3 normally open redundant-output contacts)
IM-T-11A	61424	Interface Module (2 normally open redundant-output contacts plus 1 normally closed auxiliary output contact)

Interface Modules provide isolated safety contacts for a Primary Safety Device (the EZ-SCREEN Grid System). See data sheet p/n 62822 for more information.

Lens Shields

NOTE: The total range decreases by approximately 10% per shield.



Model	Part Number	Fits EZ-SCREEN Models	Length
EZS-684	61949	SG..E/R2-500	684 mm
EZS-768	61950	SG..E/R2-584	768 mm
EZS-984	61951	SG..E/R3-400	984 mm
EZS-1251	61952	SG..E/R3-533	1251 mm
EZS-1084	61953	SG..E/R4-300	1084 mm

Mirrors

NOTE: The total range decreases by approximately 8% per mirror.

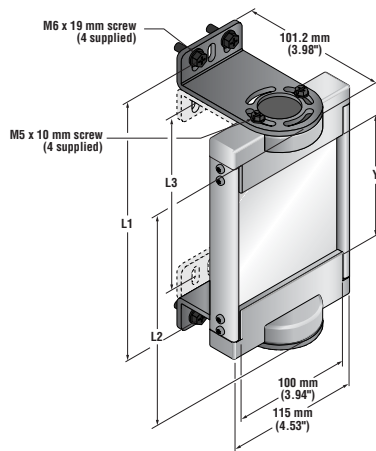

Model	Part Number	Fits EZ-SCREEN Models	Length			
			Y	L1	L2	L3
SSM-550	61895	SG..2-500	550 mm (21.7")	661 mm (26")	628 mm (24.7")	603 mm (23.7")
SSM-675	61896	SG..2-584	675 mm (26.6")	786 mm (31")	753 mm (29.6")	728 mm (28.7")
SSM-975	61898	SG..3-400 SG..4-300	975 mm (38.4")	1086 mm (42.8")	1053 mm (41.5")	1028 mm (40.5")
SSM-1175	61899	SG..3-533	1175 mm (46.3")	1286 mm (50.6")	1253 mm (49.3")	1228 mm (48.3")

Accessory Mounting Brackets

NOTE: EZA-MBK-1 Standard end cap bracket kit is included with emitter and receiver.
See Appendix page 59 for accessory bracket dimensions.

Model	Part Number	Description
EZA-MBK-2	61947	Adapter Bracket Kit for MSA Series Stands
EZA-MBK-3	61980	Side-Swivel Bracket Kit
EZA-MBK-8	62771	Retrofit Bracket Kit (to replace SICK/Leuze Grid systems)
EZA-MBK-9	66013	Adjustable Bracket Kit

MSA Series Stands

Model	Part Number	Height	To Fit Sensor Models	To Fit Mirror Models
MSA-S42-1	43175	42"	SG..2-584, SG..2-500	SSM-550, SSM-675
MSA-S66-1	43176	66"	SG..3-533, SG..3-400, SG..4-300	SSM-975, SSM-1175

NOTE: One EZA-MBK-2 Adaptor Bracket Kit required per sensor

2.3 Replacement Parts

Model	Part Number	Description
MGA-KS0-1	30140	Keyed reset switch (same as that included in kits)
MGA-K-1	28513	Replacement key for switch MGA-KS0-1
EZA-AP-1	62859	Access port plug with o-ring
EZA-CP-13	62860	Pg13.5 plug with o-ring
EZA-ECR-1	62857	Receiver wiring chamber end cap (with gasket, captive screws, 3 plugs with o-rings, terminal block)
EZA-ECE-1	62858	Emitter wiring chamber end cap (with gasket, captive screws, 3 plugs with o-rings, terminal block)
EZA-TBE-1	62861	Emitter terminal block
EZA-TBR-1	62862	Receiver terminal block
EZA-SW-1	62863	Spanner wrench
EZA-MBK-1	60630	Standard end cap bracket kit (with hardware)
STP-3	43958	Test Piece, 1.75" dia.
SMA-MBK-1	61933	SSM Series Mirror Bracket Kit

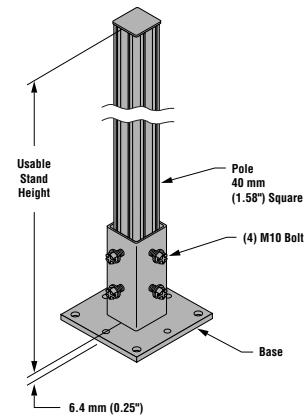

2.4 Literature

60632	Manual
60633	Daily Checkout Card
60634	Semi-Annual Checkout Card

2.5 Specifications

EZ-SCREEN Grid System Specifications

Supply Voltage (V in)	24V dc \pm 15%, 10% maximum ripple Emitter: 150 mA max. Receiver: 500 mA max., exclusive of OSSD1 and OSSD2 loads (up to an additional 0.5A each)
Short Circuit Protection	All inputs and outputs are protected from short circuits to +24V dc or dc common (except Emitter AUX power connections; see Section 3.5)
Response Time	24 milliseconds or less from interruption of light grid beam to safety outputs going to OFF-state
Safety Rating	Type 4 per IEC 61496-1, -2; Category 4 per ISO 13849-1/EN 954-1
EDM Input	+24V dc signals from external device contacts can be monitored (single-channel, dual-channel or no monitoring) via EDM1 and EDM2 terminals in the receiver (see Section 3.7.3). Monitored devices must respond within 200 milliseconds of an output change.
Reset Input	The Reset input must be high (10 to 30V dc at 30 mA) for 0.25 to 2 seconds and then low (less than 3V dc) to reset the receiver.
Remote Test Input	Test mode is activated either by applying a low signal (less than 3V dc) to emitter TEST1 terminal for a minimum of 50 milliseconds, or by opening a switch connected between TEST1 and TEST2 terminals for a minimum of 50 milliseconds. Beam scanning stops to simulate a blocked condition. A high signal (10 to 30V dc, 35 mA inrush, 10 mA max.) at TEST1 terminal de-activates Test mode and allows the emitter to operate normally. TEST1 and TEST2 are factory jumpered. (See Section 3.7.4 for more information.)
Outputs (See Warnings on page 33.)	Two diverse-redundant solid-state 24V dc, 0.5 A max. sourcing OSSD (Output Signal Switching Device) safety outputs. (Use optional interface modules for ac or larger dc loads.) Capable of the Banner "Safety Handshake" (see Section 1.1). ON-State voltage: \geq Vin-1.5V dc OFF-State voltage: 1.2V dc max. Max. load resistance: 1000 ohm Max. load capacitance: 0.1 μ F
Controls and Adjustments	Emitter: Scan code selection: 2-position switch (code 1 or 2). Factory default position is 1. Receiver: Scan code selection: 2-position switch (code 1 or 2). Factory default position is 1. Trip/latch output selection: redundant switches. Factory default position is L (latch). EDM/MPCE monitor selection: redundant switches select between 1- or 2-channel monitoring. Factory default position is 2.
Emitter/Receiver Operating Range (See Caution on page 6.)	Short-range models: 0.8 m to 20 m (2.6' to 65') Long-range models: 15 m to 70 m (49' to 230') Range decreases with use of mirrors and/or lens shields; see Section 2.2.
Beam Spacing (See dimension drawing, Figure 2-1, for beam locations.)	Model SG...4-300: 300 mm (11.8") Model SG...3-400: 400 mm (15.7") Model SG...2-500: 500 mm (19.7") Model SG...3-533: 533.4 mm (21") Model SG...2-584: 584.2 mm (23")
Beam Diameter	25 mm (1")
Ambient Light Immunity	> 10,000 lux at 5° angle of incidence
Strobe Light Immunity	Totally immune to one Federal Signal Corp. "Fireball" model FB2PST strobe
Emitter Elements	Infrared LEDs, 880 nm at peak emission

EZ-SCREEN Grid System Specifications (continued)

<p>Effective Aperture Angle (EAA)</p>	<p>Meets Type 4 requirements per IEC 61496-2, Section 5.2.9 Short-range models: ± 2.5° @ 3 m Long-range models: ± 2.5° @ 15 m</p>
<p>Enclosure</p>	<p>Size: See Figure 2-1 Materials: Extruded aluminum housings with yellow polyester powder finish and well-sealed, rugged molded PBT end caps, acrylic lens cover Rating: NEMA 4, 13; IEC IP65</p>
<p>Operating conditions</p>	<p>Temperature: 0° to +50° C (+32° to 122°F) Max. Relative Humidity: 95% maximum relative humidity (non-condensing)</p>
<p>Shock and Vibration</p>	<p>EZ-SCREEN systems have passed vibration and shock tests according to IEC 61496-1 and -2. This includes vibration (10 cycles) of 10-55 Hz at 0.35 mm (0.014") single amplitude (0.70 mm peak-to-peak) and shock of 10 g for 16 milliseconds (6,000 cycles).</p>
<p>Status Indicators</p>	<p>7-Segment Diagnostic Indicators, Both Emitter and Receiver Dash (–) = System is OK Error Codes = See Section 5.1 for code definitions and recommended action Scan code setting (C1 or C2) = Appears during power-up or after scan code is changed. (Temporary indication; normal display resumes within a few seconds.)</p> <p>Emitter: One bi-color (red/green) Status indicator Green steady = RUN mode Green single flashing = TEST mode Red single flashing = Lockout (see Section 5.1.2) OFF = No power to sensor</p> <p>Receiver: Two system Status indicators, plus one bi-color (red/green) Beam Status indicator for each beam</p> <p>Yellow Reset Indicator ON steady = RUN mode Double flashing = Waiting for manual reset after power-up Single flashing = Waiting for manual latch reset OFF = No power to sensor or system is not ready for operation</p> <p>Bi-Color (Red/Green) Status Indicator Green steady = Outputs ON Red steady = RUN mode, outputs OFF Red single flashing = Lockout (see Section 5.1.1) OFF = No power to sensor or system is not ready for operation</p> <p>Bi-Color (Red/Green) Beam Status Indicators Green steady = Clear beam, strong signal Green flickering = Clear beam, weak signal Red steady = Beam blocked OFF = No power to sensor or no scanning</p> <p>See Figure 1-5 for indicator locations.</p>
<p>Mounting Hardware</p>	<p>Emitter and receiver each are supplied with a pair of swivel end mounting brackets. Mounting brackets are 8-gauge cold-rolled steel, black zinc finish.</p>
<p>Cables and Connections</p>	<p>Cables are user-supplied. Wiring terminals accommodate one 22 to 16 ga. wire or two wires up to 18 ga.; Pg13.5 wiring chamber access port capacity varies, depending on cable gland or strain relief fitting used. Supplied cable gland is for a cable diameter of 6 to 12 mm (0.236" to 0.472").</p>
<p>Certifications</p>	<p> Other certifications pending; contact factory for further information</p>

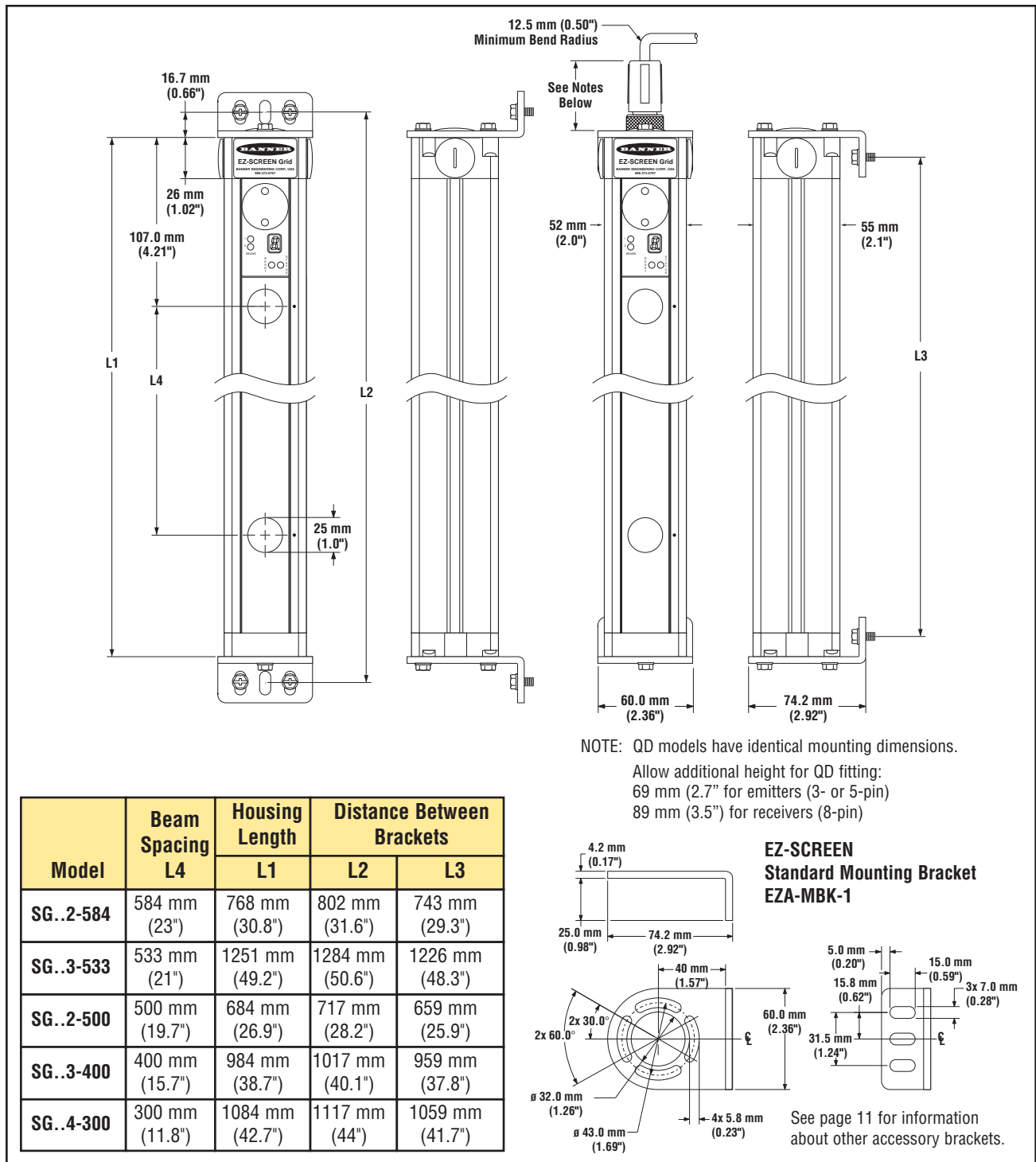

Figure 2-1. EZ-SCREEN dimensions (standard end-cap brackets shown) and EZA-MBK-1 mounting bracket dimensions

2.6 Dimensions

Figure 2-1 shows the dimensions of the five basic configurations, including the placement of the individual beams. Note that beam spacing varies from model to model; the beam spacing selected depends on the specific standard(s) being satisfied for the individual application.

3. Installation and Alignment

Read Section 3 in its entirety before installing the Banner EZ-SCREEN Grid System. The Banner EZ-SCREEN Grid System’s ability to perform its safety guarding function depends upon the appropriateness of the application and upon its proper mechanical and electrical installation and interfacing to the guarded machine. If all mounting, installation, interfacing, and checkout procedures are not followed properly, the EZ-SCREEN Grid System cannot provide the protection for which it was designed. Installation must be performed by a Qualified Person, as defined in the Safety Glossary in this manual. See Warning at right.

3.1 Appropriate Applications

The Banner EZ-SCREEN Grid System may be used to guard only machinery that can be stopped immediately after a stop signal is issued. It may be used with part-revolution clutched machines that have the ability to stop at any point in their stroke. **Under no circumstances may the EZ-SCREEN Grid System be used to guard full-revolution clutched machinery. Banner EZ-SCREEN Grid Systems may not be used as tripping devices to initiate machine motion (PSDI applications) on mechanical power presses, per OSHA regulation 29 CFR 1910.217.**

The Banner EZ-SCREEN Grid System is typically used in access-guarding or perimeter-guarding applications for the following types of machines:

- Assembly stations
- Manufacturing cells
- Automated production equipment
- Robotic work cells

The Banner EZ-SCREEN Grid System may not be used in the following types of applications:

- For finger or hand detection in point-of-operation guarding; its beam spacing is larger than that allowed for finger or hand detection in these applications,
- For non-vertical area-guarding applications,
- To guard any machine that cannot be stopped immediately after a stop signal is issued, such as single-stroke (or “full-revolution”) clutched machinery,
- To guard any machine with inadequate or inconsistent machine response time and stopping performance,
- To guard any machine that ejects materials or component parts through the area protected by the EZ-SCREEN Grid, or
- In any environment that is likely to adversely affect photoelectric sensing system efficiency. For example, corrosive chemicals or fluids or unusually severe levels of smoke or dust, if not controlled, may degrade the efficiency of the safety light grid.



WARNING . . .
Read this Section Carefully Before Installing the System

The user is responsible for satisfying all local, state, and national laws, rules, codes, or regulations relating to the installation and use of this control system in any particular application. Extreme care should be taken to meet all legal requirements and follow all technical installation and maintenance instructions contained in this manual.

The user has the sole responsibility to ensure that the Banner EZ-SCREEN Grid System is installed and interfaced to the guarded machine by Qualified Persons in accordance with this manual and applicable safety regulations.

Read all of Section 3 of this manual carefully before installing the system. Failure to follow these instructions could result in serious bodily injury or death.



CAUTION . . .
Install System Only on Appropriate Applications

In order for the machinery guarded by the EZ-SCREEN Grid system to be stopped as described, that machinery must be capable of stopping at any point in its machine cycle. This means that the EZ-SCREEN Grid system cannot be used with certain types of machinery (see listing at left).

If there is any doubt about whether or not your machinery is compatible with the EZ-SCREEN Grid system, contact a Banner factory application engineer.

3.2 Security Protocol

Certain procedures for installing, maintaining and operating the EZ-SCREEN Grid system must be performed by either *Designated Persons* or *Qualified Persons*.

A **Designated Person** is identified and designated in writing, by the employer, as being appropriately trained and qualified to perform the specified checkout procedures on the EZ-SCREEN Grid system. A machine operator so designated may be a Designated Person. The Designated Person is empowered to:

- Perform manual resets and hold possession of the reset key, and
- Perform the Daily Checkout Procedure (see Section 6).

A **Qualified Person**, by possession of a recognized degree or certificate of professional training, or by extensive knowledge, training and experience, has successfully demonstrated the ability to solve problems relating to the installation of the EZ-SCREEN Grid System and its integration with the guarded machine. In addition to everything for which the Designated Person is empowered, the Qualified Person is empowered to:

- Install the safety light grid system,
- Perform all safety light grid checkout procedures (see Section 6),
- Have access and make changes to the internal light grid configuration settings and hold possession of the Banner spanner wrench that opens the configuration access port plug, and
- Reset the system following a lockout condition.

Resetting the System

System resets are performed using an external Reset switch. This switch must be located outside the guarded area, and not within reach of anyone inside the guarded area (see Section 3.4). Its location should provide a clear view of the entire safeguarded area. If any hazardous areas are not within view from the switch location, additional means of safeguarding must be provided.

The switch should be protected from accidental or unintended actuation (e.g., through the use of rings or guards).

If supervisory control of the Reset switch is required, a key switch may be used, with the key kept in the possession of a Designated or Qualified Person. Using a key switch will also provide some level of personal control, since the key may be removed from the switch. This will hinder a reset while the key is under the control of an individual, but must not be relied upon solely to guard against accidental or unauthorized reset. Spare keys in the possession of others or additional personnel entering the safeguarded area unnoticed may create a hazardous situation.

Reset Routine

The EZ-SCREEN requires a manual reset to clear a latch condition and resume operation following a stop command. To perform a manual reset, close the normally open Reset switch for a least 1/4 second, but not longer than 2 seconds, and then re-open the switch. Internal lockout conditions also require a manual reset to return the system to RUN mode after the failure has been corrected and the input correctly cycled.

3.3 Mechanical Installation Considerations

Two factors have the greatest influence on the mechanical installation of the EZ-SCREEN System:

- The required separation (safety) distance, and
- The presence of hard guarding.

3.3.1 Minimum Separation Distance (D_s)

Minimum Separation (Safety) Distance (D_s) is the minimum distance required between the light grid and the closest reachable hazard point. Separation distance is calculated so that the EZ-SCREEN Grid System will send a stop signal to the machine when an object or a person is detected (by blocking a sensing beam), allowing the machine to come to a stop by the time the person can reach any machine hazard point.

After the D_s is determined, record the calculated distance in Section 6.4 (step 2) of this manual, and/or on the Daily Checkout Card.

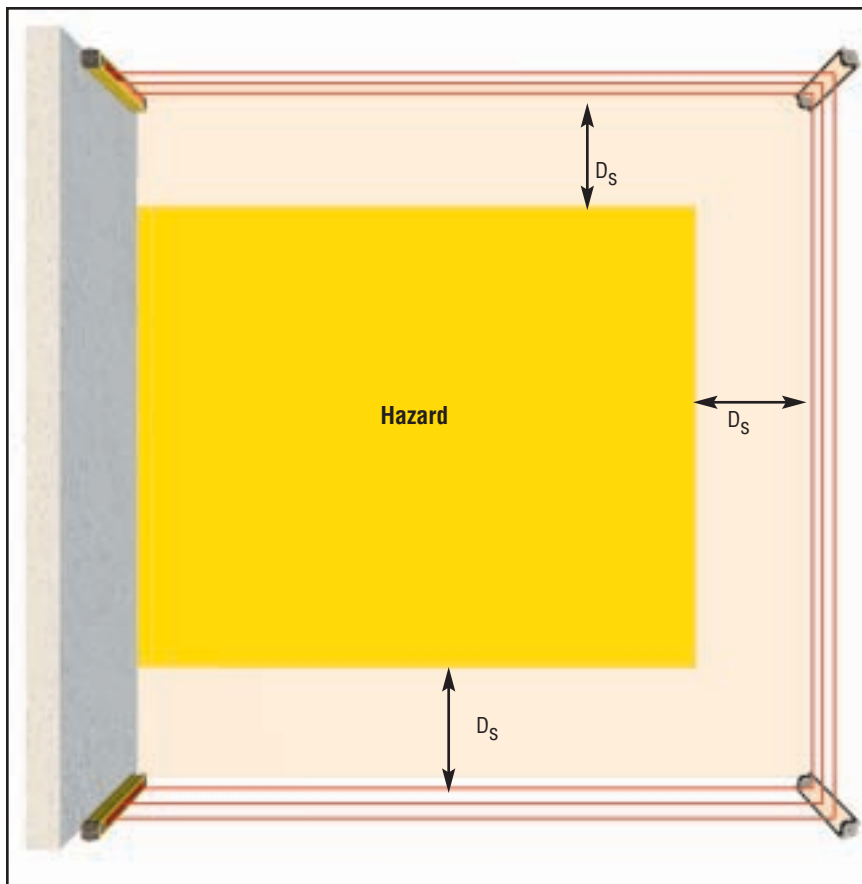

Figure 3-1. Separation distance

Notice Regarding MPCEs

Each of the two Machine Primary Control Elements (MPCE 1 and MPCE2) must be capable of immediately stopping the dangerous machine motion, irrespective of the state of the other. These two channels of machine control need not be identical, but the stop time performance of the machine (T_s , used to calculate the separation distance) must take into account the slower of the two channels.

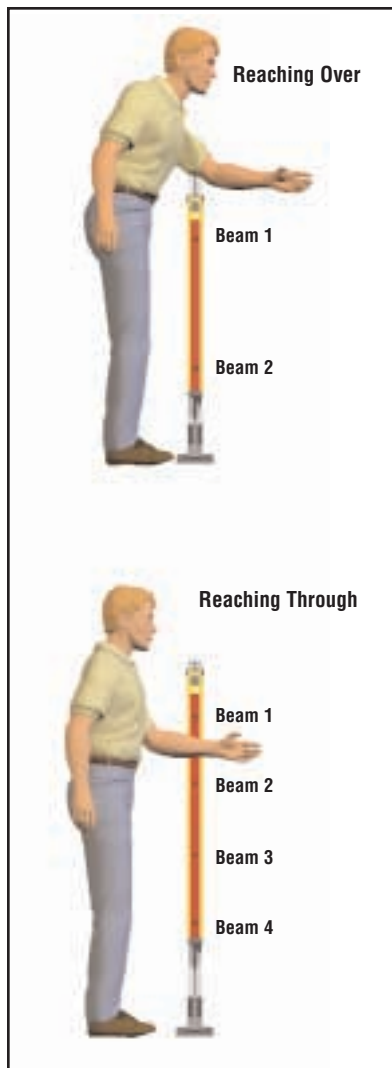

Figure 3-2. Determining D_{pf} (reach-through versus reach-over hazards per ANSI/RIA R15.06)

Calculation of separation distance takes into account several factors, including a calculated human speed, the total system stopping time (which itself has several components), and the depth penetration factor. The formula used to calculate separation distance is:

$$D_s = K \times (T_s + T_r) + D_{pf}$$

where:

D_s = the separation distance, in inches;

K = 63" per second (or 1600 mm per second), the OSHA-recommended (or EN 999-recommended) hand-speed constant¹;

T_s = the overall stop time of the machine (in seconds) from the initial "stop" signal to the final ceasing of all motion (including stop times of all relevant control elements, and measured at maximum machine velocity)². See the Warnings on page 20, and the Notice Regarding MPCEs (at left).

This measurement must take into account the slower of the two MPCE channels, and the response time of all devices or controls (such as interface modules) that react to stop the machine. **If all devices are not included, the calculated separation distance (D_s) will be too short and serious injury could result.**

T_r = 0.024 seconds, the maximum response time of the EZ-SCREEN Grid System; and

D_{pf} = 36" or 48", the added distance due to depth penetration factor (for U.S. applications, prescribed in ANSI/RIA R15.06 and ANSI B11). Because the beam spacing of the EZ-SCREEN Grid is larger than 2.5" but less than 24", D_{pf} is either 36" or 48":

- D_{pf} is 36" if the top beam is 48" or higher and the bottom beam is 12" or less from the floor (a reach-through hazard).
- D_{pf} is 48" if the top beam is 36" to 48" above the floor and the bottom beam is 12" or less from the floor (a reach-over hazard).

In European applications, D_{pf} is 850 mm, prescribed in EN 999.

NOTES:

- 1) The OSHA-recommended hand speed constant K has been determined by various studies, and although these studies indicate speeds of 63"/second to more than 100"/second, they are not conclusive determinations. The user should consider all factors, including the physical ability of the operator, when determining the value of K to be used.
- 2) T_s is usually measured by a stop-time measuring device. If the machine manufacturer's specified stop time is used, at least 20% should be added to allow for possible clutch/brake system deterioration.

U.S. Applications:

Using the formula,

$$D_S = K \times (T_S + T_r) + D_{pf}$$

separation distance for a model SG..3-533 EZ-SCREEN Grid System (42" protected height with 3 beams, 21" apart) is calculated (per ANSI/RIA R15.06):

$$K = 63"/\text{second}$$

$$T_S = 0.32 \text{ (0.250 second is specified by the machine manufacturer; plus 20\% safety factor; plus 20 ms for interface module IM-T-9A response)}$$

$$T_r = 0.024, \text{ the maximum response time of the EZ-SCREEN Grid System in seconds; and}$$

$$D_{pf} = 36"$$

$$D_S = 63 \times (0.32 + 0.024) + 36$$

$$D_S = 58"$$

In this example, the EZ-SCREEN Grid emitter and receiver must be mounted so that no part of the light grid will be closer than 58" from the closest reachable hazard point of the guarded machine.

European Applications:

Using the same formula, separation distance for a model SG..3-400 EZ-SCREEN Grid System (800 mm protected height with 3 beams, 400 mm apart), is calculated (per EN 999):

$$K = 1600 \text{ mm/second}$$

$$T_S = 0.32 \text{ (0.250 second is specified by the machine manufacturer; plus 20\% safety factor; plus 20 ms for interface module IM-T-9A response)}$$

$$T_r = 0.024, \text{ the maximum response time of the EZ-SCREEN Grid System in seconds; and}$$

$$D_{pf} = 850 \text{ mm}$$

$$D_S = 1600 \times (0.32 + 0.024) + 850$$

$$D_S = 1400 \text{ mm}$$

In this example, the EZ-SCREEN Grid emitter and receiver must be mounted so that no part of the light grid will be closer than 1400 mm from the closest reachable hazard point of the guarded machine.

NOTE: Other machine standards may require different separation factors from those illustrated. Also, workers'/operators' abilities, plant procedures and other factors may affect D_S .



CAUTION . . .
Position Components Carefully

The emitter and receiver must be positioned so that the hazard cannot be accessed by reaching over, under, around or through the sensing field. Supplemental safeguarding may be required; see Section 3.3.2.



CAUTION . . .
Adequate Separation Distance

The emitter and receiver must be positioned a safe distance from hazardous areas, as described by OSHA standards in Section 1910.217 (c)(3)(iii)(e). Also see Section 3.3 of this manual.

Failure to do so could result in serious bodily injury or death.



CAUTION . . .
Determining Correct Stop Time

Be sure to include the stop time of all relevant devices and controls in your calculations. Failure to do so could result in serious bodily injury or death.

Figure 3-3. Calculating separation distance, two examples



WARNING . . .
The Machine Hazard
Must Be Accessible
Only Through the
Light Grid

Mechanical barriers (“hard guarding”) or supplemental safeguarding, as described by the ANSI B11 series of safety requirements or other appropriate standards, **must be installed wherever needed to prevent any person from:**

- Reaching around, under, or over the light grid and accessing the hazard, and
- Entering or remaining anywhere within the guarded area without being detected and a stop command being issued to the guarded machine (see ANSI/RIA R15.06).

3.3.2 Supplemental Safeguarding

Supplemental safeguarding is used to make the hazard point accessible only through the light grid, per ANSI/RIA R15.06. This means that mechanical barriers (such as screens or bars) or supplemental safeguarding must be installed, wherever needed, to prevent any person from entering into or remaining in the hazard area undetected. The use of mechanical barriers for this purpose is called hard guarding (see the Warning at left and Figure 3-4).

There must be no gaps between the hard guarding and the edges of the light grid (that is, the EZ-SCREEN emitter or receiver). Also, OSHA specifies a relationship between the distance of the hard guard barrier from the point of operation and the maximum allowable size of openings in that barrier (see OSHA 1910.217, Table O-10). Openings in the hard guard material must meet OSHA or other applicable criteria.

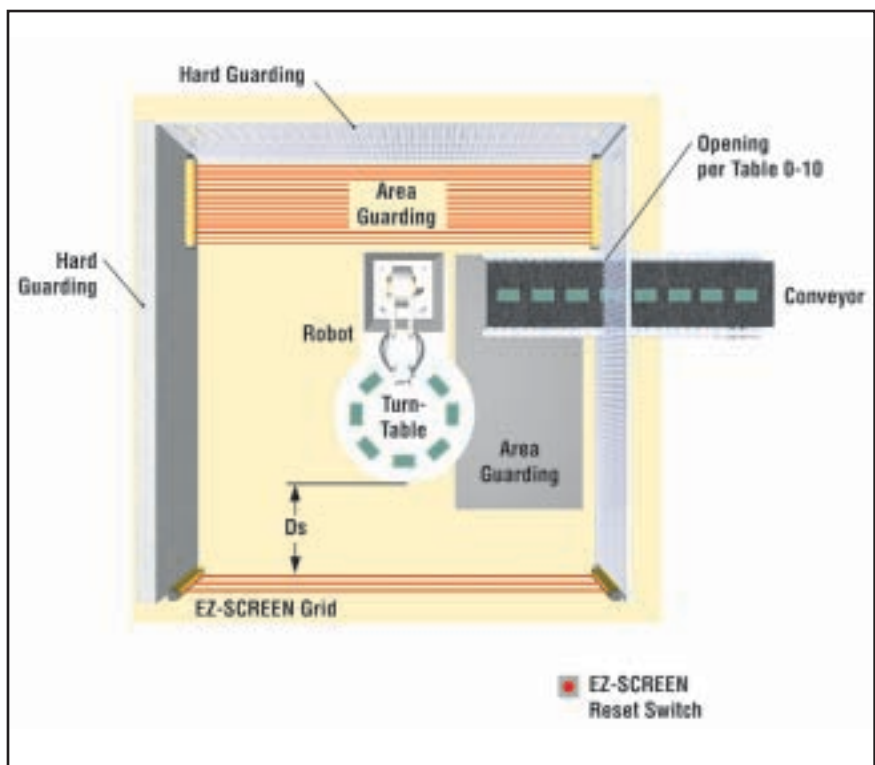



Figure 3-4. An example of supplemental safeguarding

Figure 3-4 shows an example of supplemental safeguarding inside a robotic work cell. The EZ-SCREEN (emitter and receiver) in conjunction with the hard guarding (i.e. the wall and the fencing) is the primary safeguarding. Supplemental safeguarding (such as a horizontal mounted safety light screen as an area guard) is required in areas that can not be viewed from the EZ-SCREEN Reset switch (i.e. behind the robot and the conveyor). Additional supplemental safeguarding may be required by relevant standards, such as preventing clearance or trapping hazards as described by ANSI/RIA R15.06 (e.g. the safety mat as an area guard between the robot, the turntable, and the conveyor).

3.3.3 Emitter/Receiver Orientation

The emitter and receiver must be mounted vertically, and parallel to each other, with their displays either both at the top or both at the bottom. Otherwise dangerous voids in the light grid could allow objects or personnel to pass undetected through the grid (see Figure 3-5). **Be certain the light grid covers all access to the guarded area not otherwise protected by hard guarding or other supplemental guarding.**



WARNING . . .
Proper Emitter/Receiver Orientation

Emitters and receivers must be installed with their displays either both at the top or both at the bottom.

Failure to do so will impair the performance of the EZ-SCREEN System and result in incomplete guarding; serious bodily injury or death could result.

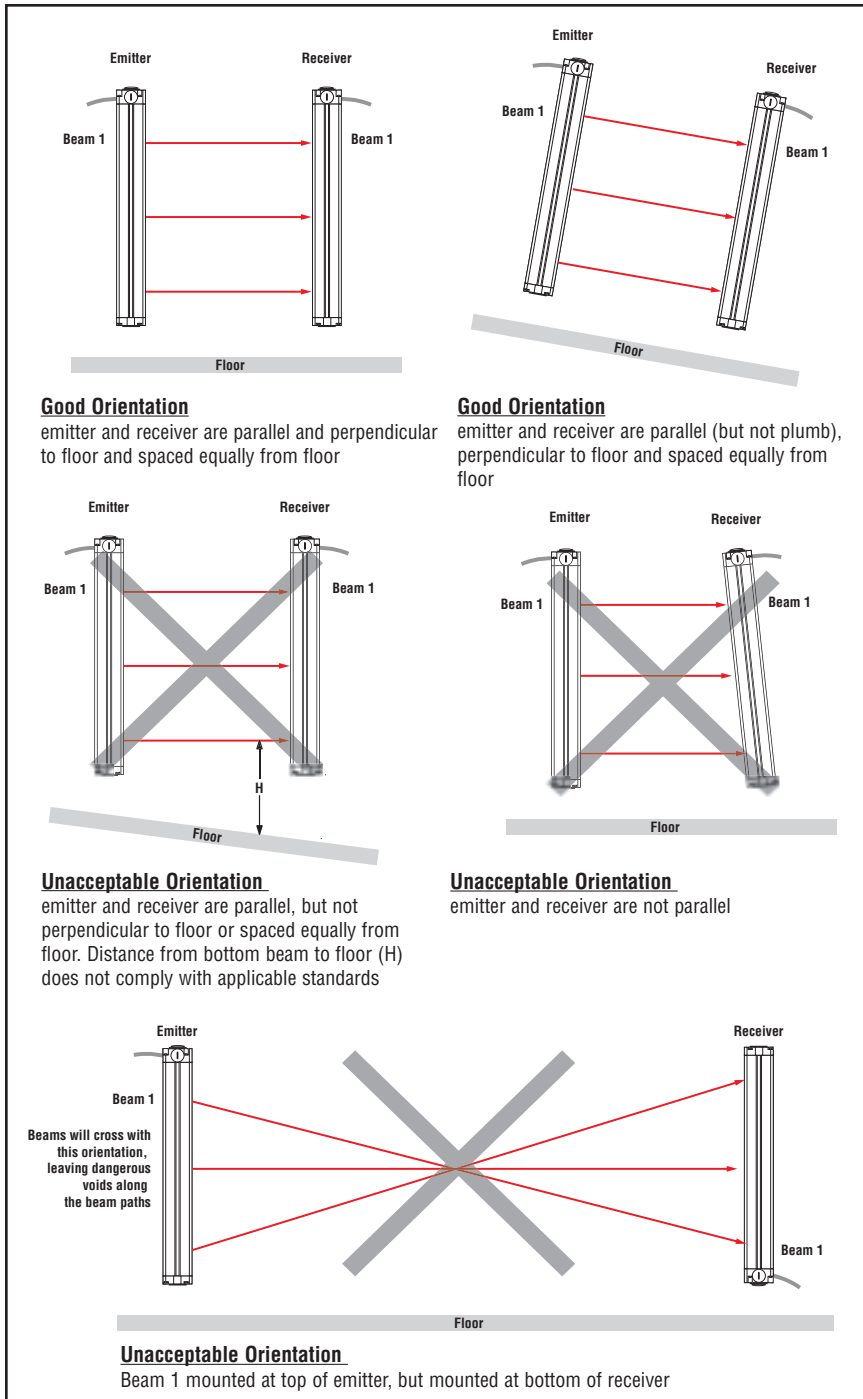

Figure 3-5. Emitter/receiver orientation



WARNING . . .
Avoid Installation Near Reflective Surfaces

Avoid mounting the light grid near any reflective surfaces. A reflective surface located nearby may reflect light around an object or person within the light grid, preventing its detection by the light grid. This possibility is detected during the trip test.

Failure to prevent reflection problems will result in incomplete guarding; serious bodily injury or death could result.

3.3.4 Adjacent Reflective Surfaces

A reflective surface located adjacent to the light grid may deflect one or more beams around an object in the light grid. In the worst case, such a situation may allow an object to pass undetected through the light grid.

This reflective surface may result from shiny surfaces or glossy paint on the machine, the workpiece, the floor or the walls.

Beams deflected by reflective surfaces are discovered by performing the trip test portion of the final alignment procedure and the periodic checkout procedures (Sections 3.6 and 6). **To eliminate problem reflections:**

- **If possible, relocate the sensors** to move the beams away from the reflective surface(s), being careful to maintain adequate separation distance.
- **Otherwise, if possible, paint, mask or roughen the shiny surface** to reduce its reflectivity.
- **Where these are not possible (as with a shiny workpiece)**, include a means of restricting the receiver's field of view or the emitter's spread of light in the sensor mounting.
- **Repeat the trip test** to verify that these changes have eliminated the problem reflection(s). If the workpiece is especially reflective and comes close to the light grid, perform the trip test with the workpiece in place.

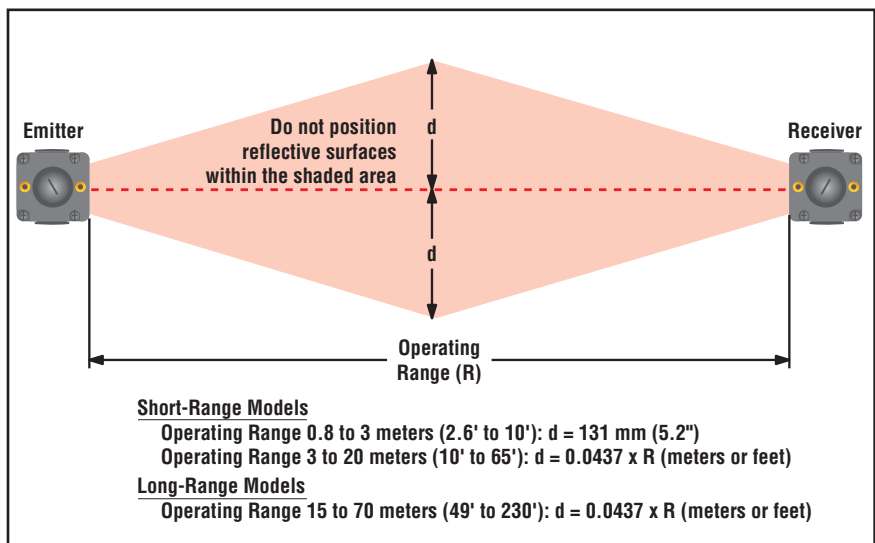



Figure 3-6. Adjacent reflective surfaces

3.3.5 Use of Corner Mirrors

EZ-SCREEN Grid Systems may be used with one or more vertical corner mirrors in perimeter-guarding applications (see Section 2.2 for availability). The use of corner mirrors reduces the maximum specified emitter/receiver separation by approximately 8 percent per mirror (see Section 3.4).

Mirrors are not allowed for applications that would allow personnel undetected access into the safeguarded area.

If mirrors are used, the difference between the angle of incidence from the emitter to the mirror and from the mirror to the receiver must be between 45° and 120° (see Figure 3-7). If placed at a sharper angle, as shown in the example, an object in the light grid may deflect beam(s) to the receiver, preventing the object from being detected (i.e., "false proxing"). Angles greater than 120° result in difficult alignment and possible optical short circuits.



WARNING . . .
Avoid Retroreflective Installation

Do not install emitters and receivers in "retroreflective" mode, with less than a 45° angle of incidence, as shown in Figure 3-7.

Sensing could be unreliable in this configuration; serious bodily injury or death could result.

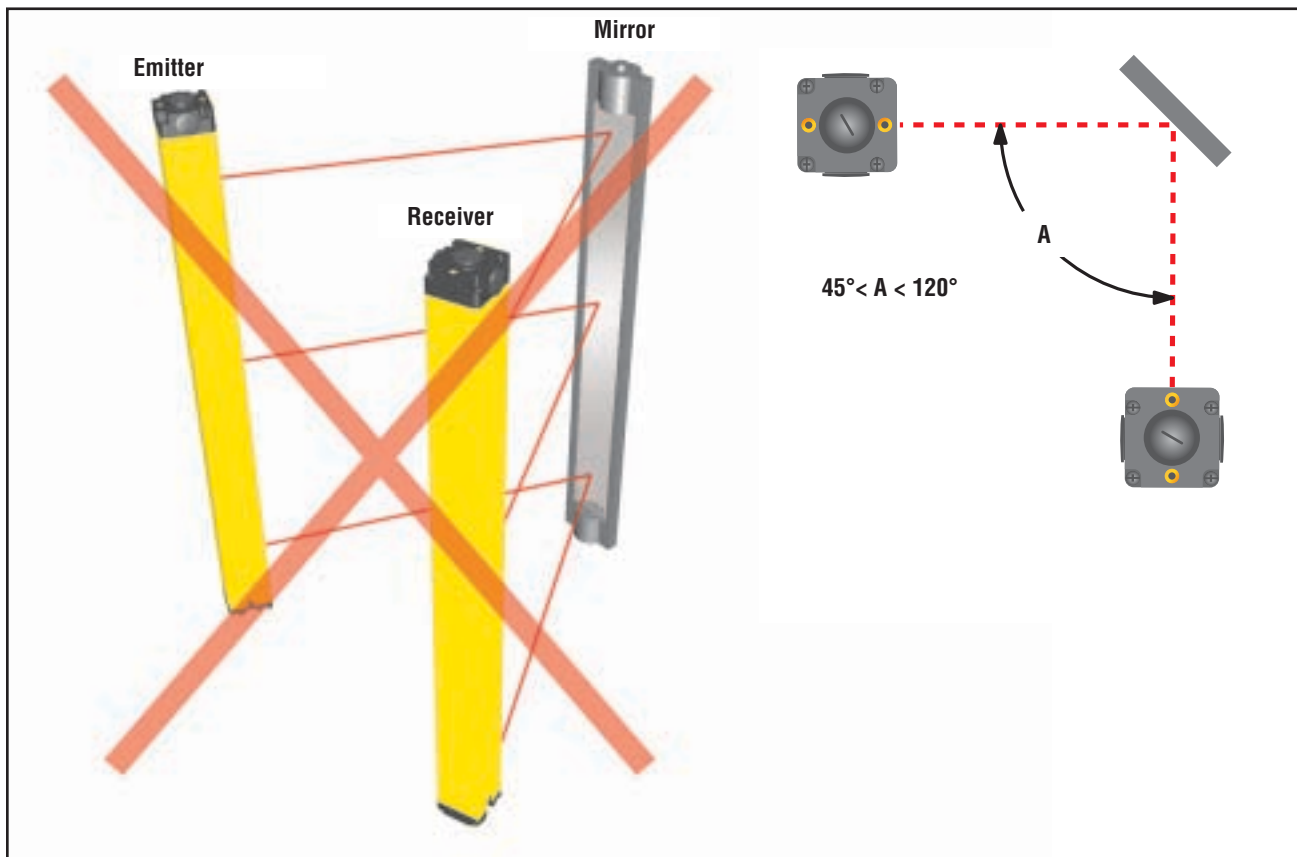

Figure 3-7. Positioning of corner mirrors

3.3.6 Avoiding Electrical and Optical Noise

The EZ-SCREEN System is designed and manufactured to be highly resistant to electrical and optical noise and to operate reliably in industrial settings. However, extreme electrical and/or optical noise may cause a random trip or latch condition. In very extreme cases, a lockout is possible. Care should be taken to avoid sources of interference when planning the mounting location.

When planning the installation, the following should be considered:

- Provide a good connection between each sensor and earth ground;
- Avoid routing sensor input or output wires close to “noisy” wiring; and
- Avoid optical interference from adjacent light grids or other photoelectrics.

See Section 5.2 for additional information.

3.3.7 Multiple-System Applications

Whenever EZ-SCREEN Grid Systems operate in close proximity with other photoelectric devices (EZ-SCREEN Grid Systems, safety light screens, or other photoelectric sensors), optical crosstalk may potentially take place between systems. Because EZ-SCREEN sensors operate at long ranges, it is especially important to carefully consider the placement of multiple sensor pairs prior to installation.

To minimize crosstalk, alternate the emitters and receivers, as shown in Figure 3-8. When three or more systems are installed more or less parallel to one another, optical crosstalk may occur between sensor pairs whose emitter and receiver lenses are oriented in the same direction. In this situation, mount the sensor pairs exactly in line with each other, and/or add an opaque light barrier between the pairs to control optical crosstalk.

To further aid in avoiding crosstalk, the sensors feature a two-position selectable scan code. A receiver set to one scan code will not “see” an emitter set to another code. See Section 4.1 for more information.

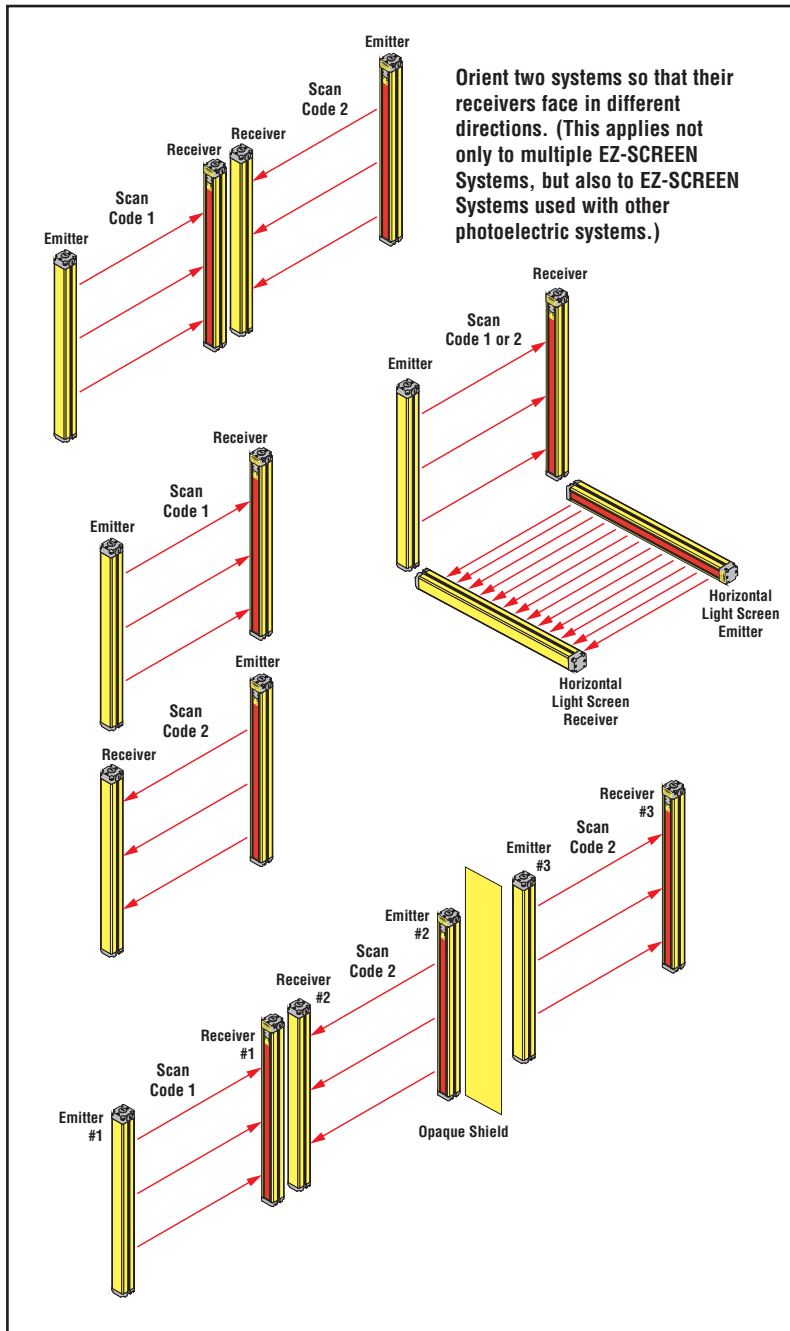

Figure 3-8. Mounting multiple EZ-SCREEN emitters and receivers to mechanically prevent optical crosstalk

3.4 Mechanical Mounting Procedure

Short-range emitters and receivers may be mounted up to 20 m (65') apart. Long-range emitters and receivers may be mounted between 15 m (49') and 70 m (230') apart. If Banner SSM corner mirrors are used, the total range decreases by approximately 8 percent per mirror, as follows:

Corner Mirrors	Short-Range Systems	Long-Range Systems
1	18.3 m (60') total	64 m (210') total
2	16.8 m (55') total	59.5 m (195') total
3	15.2 m (50') total	55 m (180') total

The emitter and the receiver must be mounted parallel to each other, with their displays either both at the top or both at the bottom; see Figure 3-5. If corner mirrors are used, they must also be mounted in the same parallel line.

Several mounting bracket options are available; refer to Section 2.2 for more information. Brackets may attach directly to EZ-SCREEN sensor end caps, or at any point along the sensor's length, using the supplied T-nuts in the housing's side slots. Bracket dimensions are shown in Figure 2-1.

Standard Brackets

The standard brackets (EZA-MBK-1), included with each sensor, may attach to the side of the housing or to the top and bottom end caps. If mounting to the end caps, the beam path may run either parallel or perpendicular to the mounting surface. The brackets allow $\pm 30^\circ$ rotation for beam alignment. Insert the two included M5 screws through the slots in the brackets, into the end cap's two threaded holes.

If mounting to the end caps, see Section 3.5 for cable routing instructions prior to attaching the housing to the bracket.

If side-mounting to the housing, lay the housing on its side and slide four T-nuts into the slot on one side of the housing. Connect a bracket near the top and near the bottom of the sensor, using two T-nuts and screws per bracket; see Figure 3-9. For easier optical alignment, swivel brackets (described below) are recommended when sensors will be side-mounted.

Stand-Mount Brackets

The accessory stand-mount brackets (EZA-MBK-2) are used in conjunction with the standard brackets described above for mounting to an MSA Series stand. They may also be used with a U-bolt for attaching to a round stand, such as Machine Guard stand MGA-S72-1.

Swivel Brackets

The accessory swivel brackets (EZA-MBK-3) mount to the sides of the housing using the same T-nuts used for the standard brackets. The two-part brackets rotate up to 180° for easy alignment. After sensors are aligned (see Section 3.6), tighten brackets firmly into place.

Adjustable Brackets

The adjustable brackets (EZA-MBK-9) mount to the housing top and bottom and allow the space between the sensor and its mounting surface to be increased or decreased. When fixed stands and bases are used, the EZA-MBK-9 brackets may be used to provide the necessary adjustability for alignment.

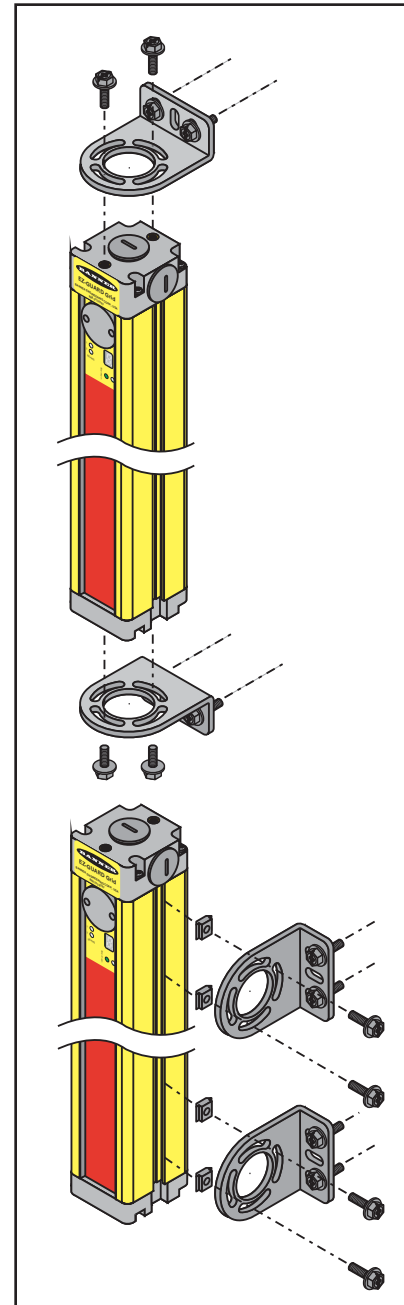

Figure 3-9. Attaching standard brackets to the end caps or side of the EZ-SCREEN

Mounting the Sensors

All system components (emitter, receiver, and corner mirrors, if used), must be parallel to each other and perpendicular to the floor. If the floor is level, the components may be checked for plumb, using a level, for example. If the floor is sloped, alignment is more complex, because the floor-to-bottom-beam measurement must remain constant, or not exceed the maximum height above the floor.

If the floor has a dip, as for a drain, or is raised up within the path of the beams, corrective measures must be taken to ensure that the requirements of ANSI/RIA R15.06, ANSI B11, or EN999 are met (see Figure 3-10). It is important that the distances between the grid's top and bottom beams and the floor meet the requirements of the applicable standards, throughout the length of the beam path.

per ANSI B11 and ANSI/RIA R15.06	Top Beam H1	Bottom Beam H2	Distance Between Adjacent Beams* H3
Reach-Over Applications (bending at the waist)	$0.9 \text{ m} \leq H1 < 1.2 \text{ m}$ ($36" \leq H1 < 48"$)	$H2 \leq 0.3 \text{ m}$ ($H2 \leq 12"$)	$H3 \leq 0.6 \text{ m}$ ($H3 \leq 24"$) *Distance between beams + beam diameter must not exceed 24". EZ-SCREEN beam is 1" + 23" spacing = 24"
Reach-Through Applications	$H1 \geq 1.2 \text{ m}$ ($H1 \geq 48"$)		
per EN999	Beam Heights Above Reference Plane (e.g., Floor)		
2-Beam Applications	0.4 m, 0.9 m (16", 36")		
3-Beam Applications	0.3 m, 0.7 m, 1.1 m (12", 28", 44")		
4-Beam Applications	0.3 m, 0.6 m, 0.9 m, 1.2 m (12", 24", 36", 48")		

The diagram shows an emitter on the left and a receiver on the right. Two horizontal red lines represent the beams. The top beam is labeled 'Beam 1' and the bottom beam is labeled 'Beam 2'. Vertical arrows indicate the heights: H1 is the distance from the top of the emitter to the top beam; H2 is the distance from the floor to the bottom beam; H3 is the distance between the two beams. The floor is shown as a grey surface with a dashed line labeled 'Level' indicating a reference plane. The floor has a slight dip in the center.

Figure 3-10. Verify required height between the top and bottom beams and the floor, throughout the length of the beam path, per applicable standards.

Installation Without Mirrors

1. If using Banner MSA series stands and bases to mount the EZ-SCREEN emitter and receiver, position the bases at the desired locations and loosely mount using the bolt locations in the four corners as described in the MSA literature. Do not tighten the mounting nuts, because the stand and sensor must still be leveled.

Other stands and bases may be used to mount the EZ-SCREEN system, but must allow the sensors to tilt (both front-to-back and side-to-side) to accommodate sloping floor surfaces and the alignment procedure. When fixed stands and bases are used, the EZA-MBK-9 brackets may be used to provide the necessary adjustability for alignment.

2. Mount the emitter and the receiver, using the supplied EZ-SCREEN mounting brackets, so that the beam closest to the floor is at the proper height, typically no more than 12" from the floor. Refer to the appropriate standards for specifics on the correct mounting of EZ-SCREEN Grid systems. Do not fully tighten the screws until the sensor is aligned.
3. Position the emitter and receiver housings so that they are perpendicular to the floor in all dimensions, with their windows facing each other. If the floor is level, use a level to check for plumb.

Installations With Corner Mirrors

If corner mirrors are used in the application, measure and position them as for the sensors. Refer to the data sheet packed with the mirrors for specific installation instructions.

1. Follow emitter/receiver installation steps 1-3 for installation without mirrors.
2. Mount the mirror(s) at the desired locations, parallel to the emitter and receiver. (Use a level to verify plumb, if the floor surface is level.) Measure up from the floor to position the center of the mirror's reflective surface at the vertical center of the beam grid, using the beam location marks on the emitter as a guide. This should allow additional reflective area above the top beam and below the bottom beam. Angle the mirror(s) relative to the sensors, so that one sensor's front surface can be seen in the first mirror when standing directly in front of the other sensor, looking into the mirror.

Mounting the Reset Switch

Mount the external Reset switch outside the guarded area, and out of reach from within the guarded area. The entire safeguarded area should be visible from the Reset switch location. If any areas are not visible, other means must be used to ensure that no personnel are within the safeguarded area during the reset (see Warning).

The Reset switch must be protected from accidental or unauthorized operation (e.g., through the use of a key, guards, or rings).

3.5 Electrical Connections

Make the electrical connections in the order described in this section. It is the user's responsibility to maintain factory-rated sealing at all cable access ports in the wiring chamber end cap of each sensor. One or more of the access ports may be used; proper wiring entrance hardware (conduit or cable gland) must be used in each opened access port in order to maintain the NEMA 4, 13; IEC IP65 rating.

NOTE: EZ-SCREEN wiring is low voltage; running these wires alongside power wires, motor/servo wires, or other high-voltage wiring, can inject noise into the EZ-SCREEN System. It is good wiring practice (and may be required by code) to isolate EZ-SCREEN System wires from high-voltage wires.

Wiring barriers in the wiring chamber end caps can accept individual conductors from #22 to #16 AWG or two conductors from #22 to #18 AWG. The wires used should have an insulation temperature rating of at least 90°C (194°F).

For easy wiring, each EZ-SCREEN sensor has a removable modular terminal block inside one end cap, at the same end as the indicators. See Figure 3-11. To make connections:

- 1) Remove the wiring chamber end cap by unscrewing the four captive screws in the end cap corners.
- 2) Remove the terminal block from the end cap.
- 3) Remove one or more of the three Pg13.5 plugs, as needed, from their threaded access ports, using the accessory spanner wrench. Insert conduit or a cable gland into the port; screw snugly into place. Follow the specific installation instructions and/or recommendations supplied by the hardware manufacturer. Unused access ports should remain factory sealed to maintain NEMA 4, 13; IEC IP65 rating.



WARNING . . . Reset Switch Location

Reset switch(es) must be:

- Outside of the hazardous area, in a location that allows the switch operator full view of the entire guarded area,
- Out of reach from within the safeguarded space, and
- Protected against unauthorized or inadvertent operation.

If any areas are not visible from the Reset switch(es), additional means of safeguarding must be provided, as described by the ANSI B11 series or other appropriate standards.

Failure to do so could result in serious injury or death.



WARNING . . . Proper Electrical Hookup

- Electrical hookup must be made by Qualified Personnel and must comply with NEC (National Electrical Code) and local standards.
- Make no connections to the System other than those described in Section 3.5 of this manual. Doing so could result in serious injury or death.

- 4) Route the wires or cabling through the bracket (if necessary) and the wiring chamber end cap. Remove outer cable insulation as necessary (approximately 1" to 2") and strip the individual wire insulation approximately 7 mm (0.25"); make connections to terminals as indicated in Figure 3-11. Torque the terminal screws to 0.22 to 0.25 N m (1.9 to 2.2 in. lbs.) recommended torque.

Emitter: *If Test input will be used*, connect the wires at the emitter terminal block and temporarily connect the other ends of the wires to each other (but not to an external contact at this time).

If Test input will not be used, leave the factory jumper in place.

Terminals 7, 8 and 9 are provided to allow convenient power connection (24V dc, 2 amp max.) to another EZ-SCREEN emitter. These terminals are a direct connection to terminals 3, 2 and 1 respectively. A 24V dc, 2-amp external fuse is recommended to limit the current on terminal 7.

Receiver: While all wires will not be connected to the machine control circuits at this time, connect the receiver end of all wires to their connections on the receiver terminal block.

If EDM will not be used (no monitoring), jumper terminals 6 and 7. (A jumper wire is supplied in the hardware kit.)

If 2-channel monitoring will be used, connect the wires to receiver terminals 6 and 7 and temporarily connect the other ends of the wires to each other (but not to the machine at this time).

If 1-channel monitoring will be used, add a jumper between terminals 6 and 7 for the initial checkout. Final EDM wiring must be completed later.

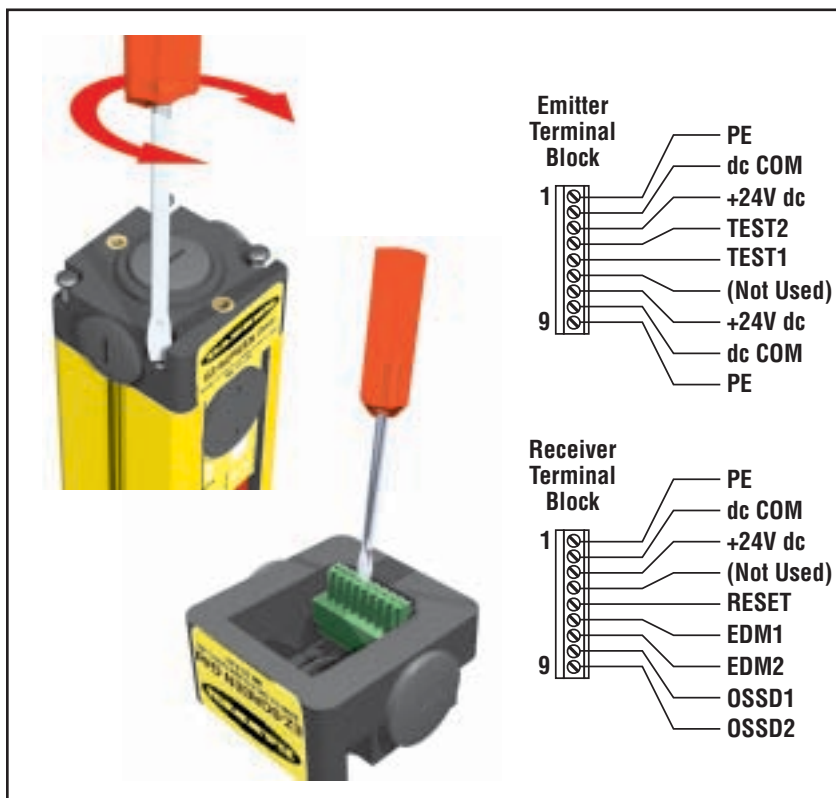

Figure 3-11. Making connections to the sensor terminal blocks

- 5) Recheck the wires to be sure connections are accurate and that wiring complies with applicable (international, national and local) codes.
- 6) Snap the terminal block back into the end cap. Replace the end cap on the end of the housing, being careful to align the end cap terminals with the corresponding terminals in the housing. When the end cap is screwed back into place on the housing, the two terminal block sections will automatically connect.

Reset Switch Hookup

Connect the external Reset switch to the Reset terminal on the receiver terminal block and to 24V dc (see Figures 3-16, 3-17 and 3-18).

Configuring the System for Initial Checkout

Verify that the System is set to the factory presets for initial checkout and optical alignment. (Factory presets are for Latch Output, 2-Channel EDM, and Scan Code 1; receiver terminals 6 and 7 should be connected, as described in step 4 above.) See Figure 4-1.

3.6 Light Grid Initial Checkout and Optical Alignment Procedure

Verifying System Operation

The initial checkout procedure must be performed by a Qualified Person (see WARNING, page 17). It must be performed only after configuring the System and after connecting the emitter and receiver per Section 3.5.

The procedure is performed on two occasions:

- To ensure proper installation when the System is first installed, and
- To ensure proper System function whenever any maintenance or modification is performed on the System or on the machinery being guarded by the System. (See Section 6.1 for a schedule of required checkouts.)

For the initial checkout, the EZ-SCREEN Grid System must be checked without power being available to the guarded machine. **Final interface connections to the guarded machine cannot take place until the light grid system has been checked out.**

Verify that:

- Power has been removed from (or is not available to) the guarded machine, its controls or actuators; and
- The machine control circuit is not connected to the OSSD outputs at this time (permanent connections will be made following this initial checkout); and
- EDM has been configured for No Monitoring, per Section 3.5.

Temporary Power

- 1) Inspect the area near the light grid (including work pieces and the guarded machine) for reflective surfaces. (Reflective surfaces may cause light beams to reflect around a person in the light grid, preventing the person from being detected and not stopping the machine motion.) Remove the reflective surfaces as possible by relocating them, painting, masking or roughening them. Remaining problem reflections will become apparent during step 5.
- 2) Verify that power is removed from the EZ-SCREEN Grid System and from the guarded machine. Remove all obstructions from the light grid. Leaving power to the guarded machine OFF, power up the EZ-SCREEN Grid System. Verify that input power is present to both emitter and receiver. *Do not operate the EZ-SCREEN Grid System without a proper earth ground at the \oplus terminal on both sensors, as shown in Figures 3-15 through 3-18.* At least one indicator on both emitter and receiver should be ON.
- 3) Observe the Beam Status indicators on the receiver to determine light grid alignment status:

A blocked condition is indicated by the Status indicator steady Red, and one or more Beam Status indicator(s) steady Red.

NOTE: If beam 1 is blocked, all other Beam Status indicators will be OFF, because beam 1 provides the synchronization signal for all the beams.

A clear condition is indicated by all Beam Status indicators steady Green. (Beam Status indicators will flicker Green if excess gain is marginal.)

A latch condition is indicated by the receiver Status indicator steady Red. Beam Status indicators may be Red, Green, or flashing Green, depending on the status of each beam. In latch output mode, the outputs come back on *only when all beams are clear and after a manual reset.*

A lockout condition is indicated by the receiver Status indicator single-flashing Red, and the receiver Reset indicator OFF.

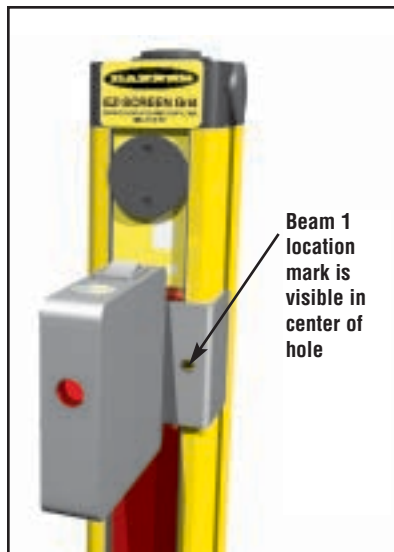

Figure 3-12. The LAT-1 Laser Alignment Tool, in position on beam 1 of the emitter

Optical Alignment Procedure

After the emitter and receiver are mechanically aligned (perpendicular to the floor along the path of the beams, and plumb in all possible directions), optically align them, first using the LAT-1, if desired, and finally using the receiver Beam Status indicators.

Using the LAT-1 for Alignment

The LAT-1 Laser Alignment Tool (see Section 2.2) is extremely helpful for initial optical alignment, especially in long-range applications and when corner mirrors are used.

The useable range of the LAT-1 (the red dot viewed at the target) depends on the color and reflectance of the target, the level of ambient light present, and the presence of airborne contaminants. With a 90 percent reflectance white test card, under average lighting and with no airborne contaminants, the red dot is viewable at approximately 150' or more. For longer ranges, the lighting should be dimmed or retroreflective targets should be used. The optional clip-on retroreflective target (EZA-LAT-1) can increase the target area and the visibility of the red dot created by the laser beam (see Figure 3-14).

NOTE: The LAT-1 should only be used at the beam 1 location to align the emitter with the receiver. Do not slide the LAT-1 along the length of either sensor; housing twist may deflect the laser beam, resulting in misalignment. Any twist in the housing (a normal occurrence) is compensated for within the EZ-SCREEN optic components.

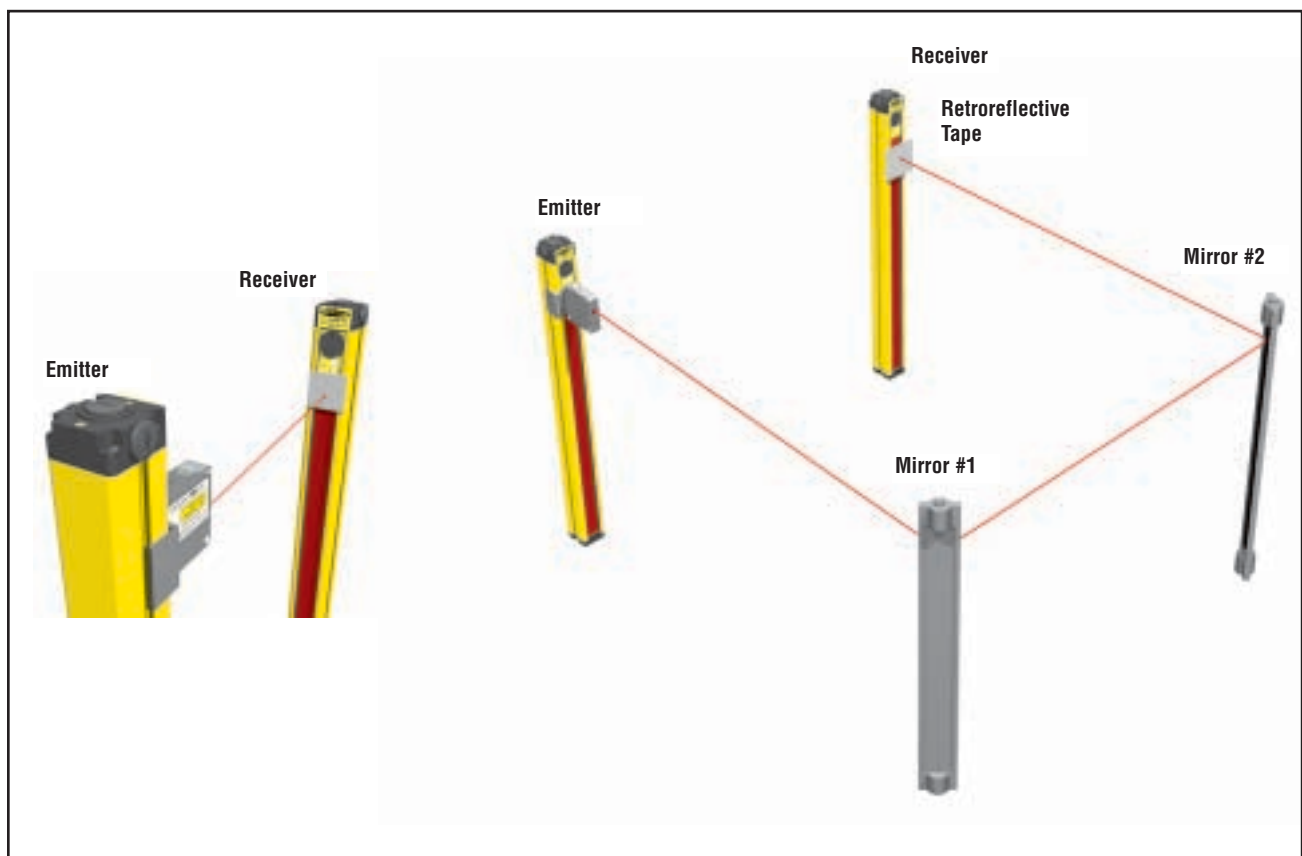

Figure 3-13. Optical alignment using the LAT-1

- 1) Attach the battery-powered LAT-1 to the housing of the emitter over the location of beam 1 (closest to the display), using the EZ-SCREEN bracket clip included with the tool. A dot on the sensor housing next to the lens window indicates the beam's location. Align the hole on the LAT-1 over the beam 1 marking (see Figure 3-12).

NOTE: To find the general direction the laser beam is pointing, place a target at arm's reach, look alongside the LAT-1, and slowly raise the target until the red dot appears on it. Using this method and rotating the emitter will send the beam in the approximate direction of the receiver. If the dot still cannot be located at the receiver (or mirror), "walk" the target down the path of the beam, while keeping the dot centered on the target, until the desired range is reached.

- 2) *If no corner mirrors are used in the application*, attach or hold a piece of reflective material, such as white paper, the reflective tape included with the LAT-1, or the optional clip-on reflective target, to the receiver at the corresponding beam 1 location. **Do not affix the self-adhesive backing of the reflective material to the sensor windows or to the mirror surfaces; the adhesive residue may not be easy to remove.** See Figure 3-13.

If corner mirrors are used, attach or hold the reflective material to the beam 1 height in the approximate center of mirror 1.

- 3) The Laser Alignment Tool emits a bright red pinpoint of light along the same path as emitter beam 1. Adjust the emitter tilt and rotation until the LAT-1 beam is centered over the receiver (or mirror) beam 1 location. Partially tighten the emitter mounting hardware to prevent misalignment when the LAT-1 is later removed. (If no mirrors are used, proceed to step 5. If mirrors are used, proceed to step 4.)
- 4) After the emitter beam 1 is aligned on the first mirror, remove the reflective material from that mirror and repeat the process on the second mirror. Repeat the process for each mirror in succession, until the laser beam shines on the reflective material positioned at receiver beam 1.
- 5) Position the LAT-1 on the receiver housing, centered over beam 1 (closest to the display). Align the receiver beam 1 as described in step 3 for the emitter. (Mirrors, if used, normally should not require realignment.) Partially tighten the receiver mounting hardware to prevent misalignment when the LAT-1 is removed, and remove the LAT-1.

Using the System for Alignment

Power-up the EZ-SCREEN Grid system and use the Beam Status indicators on the receiver to align the system by rotating the emitter and receiver sensors. Do not adjust the tilt of either sensor unless absolutely necessary to align or optimize alignment. The system alignment is optimized when all Beam Status indicators are steady Green.

When alignment is optimized, tighten the mounting screws and the mounting stand base nuts, or other mounting hardware, to secure the emitter, the receiver, and any mirrors used.

Perform the trip test (described in Section 6.2) to verify proper system operation and to detect possible reflection problems.

Do not continue operation until the entire checkout procedure is completed and all problems are corrected.

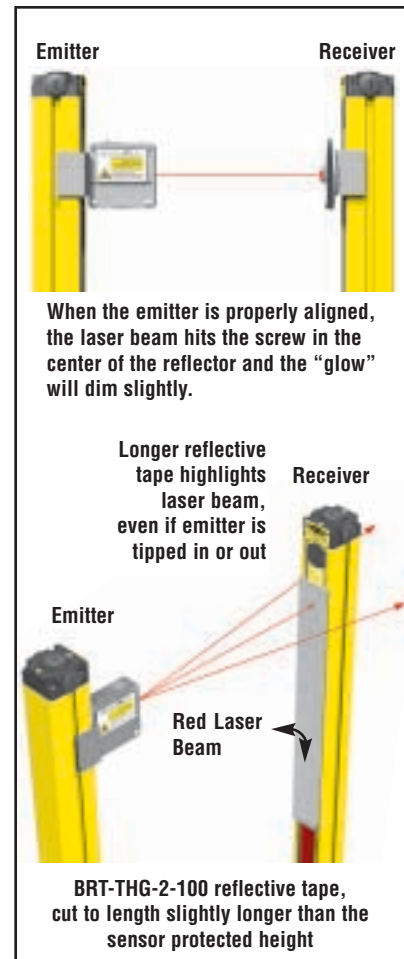

Figure 3-14. Alternate retroreflectors used for alignment

WARNING . . .
If Trip Test Indicates a Problem

If the EZ-SCREEN Grid System does not respond properly to the Trip Test, do not attempt to use the System. If this occurs, the System cannot be relied upon to stop dangerous machine motion when a person or object enters the light grid.

Serious bodily injury or death could result.



WARNING . . .
Interfacing of both
OSSDs

Both of the OSSD (Output Signal Switching Device) outputs must be connected to the machine control so that the machine's safety-related control system interrupts the circuit to the machine primary control element(s), resulting in a non-hazardous condition.

Never wire an intermediate device(s) in such a manner that the safety function can be suspended, overridden, or defeated, unless accomplished in a manner at the same or greater degree of safety.



WARNING . . .
OSSD Interfacing

To ensure proper operation, the EZ-SCREEN OSSD output parameters and machine input parameters must be considered when interfacing the EZ-SCREEN solid-state OSSD outputs to machine inputs.

Machine Control circuitry must be designed so that the maximum load resistance value is not exceeded and that the maximum specified OSSD OFF-state voltage does not result in an ON condition.

Failure to properly interface the OSSD outputs to the guarded machine could result in serious bodily injury or death.

3.7 Electrical Interface to the Guarded Machine (Permanent Hookup)

Make the electrical connections as described in Sections 3.7.1 to 3.7.4 as required by each individual application.

Supply power and the external Reset switch should be previously connected by this point. The EZ-SCREEN must also have been aligned and passed the Initial Checkout, as described in Section 3.6. The final connections to be made are:

- OSSD outputs
- FSD interfacing
- MPCE/EDM connections
- Remote Test

3.7.1 OSSD Output Connections

Both the Output Signal Switching Device (OSSD) outputs must be connected to the machine control so that the machine's safety-related control system interrupts the circuit or power to the Machine Primary Control Element(s) (MPCE), resulting in a non-hazardous condition.

Final Switching Devices (FSDs) typically accomplish this when the OSSDs go to an OFF state. See Figure 3-16.

Refer to the output specifications on page 13 and the Warning at left before making OSSD output connections and interfacing the EZ-SCREEN System to the machine.

3.7.2 FSD Interfacing Connections

FSDs (Final Switching Devices) can take many forms, though the most common are captive contact, forced-guided relays or interface modules. The mechanical linkage between the contacts allows the device to be monitored by the External Device Monitoring circuit for certain failures.

Depending on the application, the use of FSDs can facilitate controlling voltage and current that differs from the OSSD outputs of the EZ-SCREEN. FSDs can also be used to control an additional number of hazards by creating multiple safety stop circuits.

Safety Stop Circuits

A safety stop allows for an orderly cessation of motion for safeguarding purposes, which results in a stop of motion and removal of power from the MPCEs (assuming this does not create additional hazards). A Safety Stop Circuit typically comprises a minimum of two normally open (N.O.) contacts from captive contact, forced-guided relays, which are monitored (through External Device Monitoring) to detect certain failures in order to prevent the loss of the safety function. Such a circuit can be described as a "safe switching point."

Typically, safety stop circuits are either 1-channel (single channel), which is a series connection of at least two N.O. contacts; or 2-channel (dual channel), which is a separate connection of two N.O. contacts. In either method, the safety function relies on the use of redundant contacts to control a single hazard (if one contact fails ON, the second contact will arrest the hazard and prevent the next cycle from occurring).

The interfacing of the Safety Stop Circuits must be accomplished so that the safety function can not be suspended, overridden, or defeated, unless accomplished in a manner at the same or greater degree of safety as the machine's safety related control system that includes the EZ-SCREEN.

The normally open safety outputs from an interface module provide a series connection of redundant contacts that form safety stop circuits for use in either 1-channel or 2-channel control. (See Figures 3-17 and 3-18.)

2-Channel (Dual-Channel) Control

Two-channel control provides the ability to electrically extend the safe switching point beyond the FSD contacts. With proper monitoring (i.e. EDM), this method of interfacing is capable of detecting certain failures in the control wiring between the safety stop circuit and the MPCEs. These failures include a short-circuit of one channel to a secondary source of energy or voltage, or the loss of the switching ability of one of the FSD outputs. Such failures could lead to the loss of redundancy — or to a complete loss of safety, if not detected and corrected.

The possibility of a failure to the wiring increases as the physical distance between the FSD safety stop circuits and the MPCEs increase, as the length or the routing of the interconnecting wires increases, or if the FSD safety stop circuits and the MPCEs are located in different enclosures. For this reason, 2-channel control with EDM monitoring should be used in any installation where the FSDs are located remotely from the MPCEs.

1-Channel (Single-Channel) Control

One-channel control, as mentioned, uses a series connection of FSD contacts to form a safe switching point. After this point in the machine's safety-related control system, failures can occur that would result in the loss of the safety function (such as a short-circuit to a secondary source of energy or voltage).

For this reason, 1-channel control interfacing should be used only in installations where FSD safety stop circuits and the MPCEs are mounted within the same control panel, adjacent to each other, and are directly connected to each other; or where the possibility of such a failure can be excluded. If this can not be achieved, then 2-channel control should be used.

Methods to exclude the possibility of these failures include, but are not limited to:

- Physically separating interconnecting control wires from each other and from secondary sources of power.
- Routing interconnecting control wires in separate conduit, runs, or channels.
- Locating all elements (modules, switches, and devices under control) within one control panel, adjacent to each other, and directly connected with short wires.
- Properly installing multi-conductor cabling and multiple wires through strain-relief fittings. (Over-tightening of a strain-relief can cause short-circuits at that point.)
- Using positive-opening or direct-drive components, installed and mounted in a positive mode.

NOTE: MPCE Monitoring and Control Reliability

In the U.S., Control Reliability requires that a single failure does not prevent a normal stop from occurring, or issues an immediate stop command, and the next cycle is prevented from occurring until the fault is corrected.

A common method of satisfying these requirements is the use of 2-channel control with monitoring, where a normally closed, forced-guided contact of each MPCE is wired as described in the section at right and as shown in Figures 3-16, 3-17 and 3-18.



CAUTION . . . EDM Monitoring

If configured for “No Monitoring,” it is the user’s responsibility to ensure that this does not create a hazardous situation.

3.7.3 Machine Primary Control Elements and EDM Inputs

Each of the two Machine Primary Control Elements (MPCE1 and MPCE2) must be capable of immediately stopping the dangerous machine motion, irrespective of the state of the other. These two channels of machine control need not be identical, but the stop time performance of the machine (T_s , used to calculate the separation distance, see Section 3.3.1) must take into account the slower of the two channels. Some machines offer only one Primary Control Element. For such machines, it is necessary to duplicate the circuit of the single MPCE to add a second. Refer to Figures 3-16 and 3-17 or consult the machine manufacturer for additional information.

External Device Monitoring: It is strongly recommended that one normally closed, forced-guided monitoring contact of each MPCE be connected to EDM inputs (see Figures 3-16 and 3-17). If this is done, proper operation of the MPCEs will be verified. MPCE monitoring contacts is one method of maintaining control reliability.

External Device Monitoring Hookup

Terminals 6 and 7 of the receiver terminal block provide connection for the external device monitoring input. External Device Monitoring (EDM) must be wired in one of three configurations and must agree with the DIP switch EDM settings on the receiver (see Section 4.1). One- and 2-channel EDM is used when the EZ-SCREEN Grid OSSD outputs directly control the energizing and de-energizing of the guarded machine’s MPCEs.

- **One-channel monitoring** is a series connection of closed monitor contacts that are forced-guided (captive contact) from each device controlled by the EZ-SCREEN Grid. The monitoring contacts should open within 200 milliseconds of the OSSD outputs turning on (a clear condition) and should close within 200 milliseconds of the OSSD outputs turning off (a blocked condition) or a lockout will occur (see Diagnostics, Section 5.1). Refer to Figure 3-18 for 1-channel EDM hookup. Connect the monitor contacts between +24V dc and EDM1 (terminal 6). Leave EDM2 (terminal 7) open (no connection). Set the configuration DIP switches to 1, per Section 4.1.
- **Two-channel monitoring** is a separate connection of closed monitor contacts that are forced-guided (captive contact) from each device controlled by the EZ-SCREEN Grid. The monitoring contacts should always change state (both open or both closed) within 200 milliseconds of the corresponding OSSD state change (turning on or off) or a lockout will occur (see Diagnostics, Section 5.1). Refer to Figures 3-16 or 3-17 for 2-channel EDM hookup. Connect the monitor contacts as shown between +24V dc and EDM1 (terminal 6) and between +24V dc and EDM2 (terminal 7). Set the configuration DIP switches to 2, per Section 4.1.
- **No monitoring.** Use this setting initially, in order to perform the initial checkout; see Section 3.6. *If No Monitoring is selected, the user must ensure that any single failure of the external devices does not result in a hazardous condition and, in such a case, a successive machine cycle will be prevented* (see Section 1.3, Control Reliability). To configure the system for no monitoring, set the configuration DIP switches to 2, per Section 4.1, and connect a jumper (supplied) between EDM1 (terminal 6) and EDM2 (terminal 7).

3.7.4 Remote Test Input

A pair of terminals is provided on the emitter terminal block (labeled TEST1 and TEST2) for the connection of an external remote test switch (typically a normally open contact held closed). This remote test input may be useful for EZ-SCREEN Grid System setup and checkout procedures. Opening this switch “turns OFF” the emitter, simulating an interruption of the light beams; all OSSD outputs will turn OFF. The device used must be as specified in Section 2.5. (TEST1 and TEST2 terminals are factory jumpered.)

3.8 Preparing for System Operation

Perform the Commissioning Checkout, as described in Section 6.3.



WARNING . . .
Proper Wiring

The generalized wiring configurations shown are provided only to illustrate the importance of proper installation.

The proper wiring of the EZ-SCREEN Grid System to any particular machine is solely the responsibility of the installer and end user.



CAUTION. . .
Shock Hazard

Always disconnect all power from the EZ-SCREEN System and the guarded machine before making any connections or replacing any component. Use extreme caution to avoid electrical shock at all times.

Serious bodily injury or death could result.



WARNING . . .
OSSD Interfacing

To ensure proper operation, the EZ-SCREEN OSSD output parameters and machine input parameters must be considered when interfacing the EZ-SCREEN solid-state OSSD outputs to machine inputs.

Machine Control circuitry must be designed so that the maximum load resistance value is not exceeded and that the maximum specified OSSD OFF-state voltage does not result in an ON condition.

Failure to properly interface the OSSD outputs to the guarded machine could result in serious bodily injury or death.

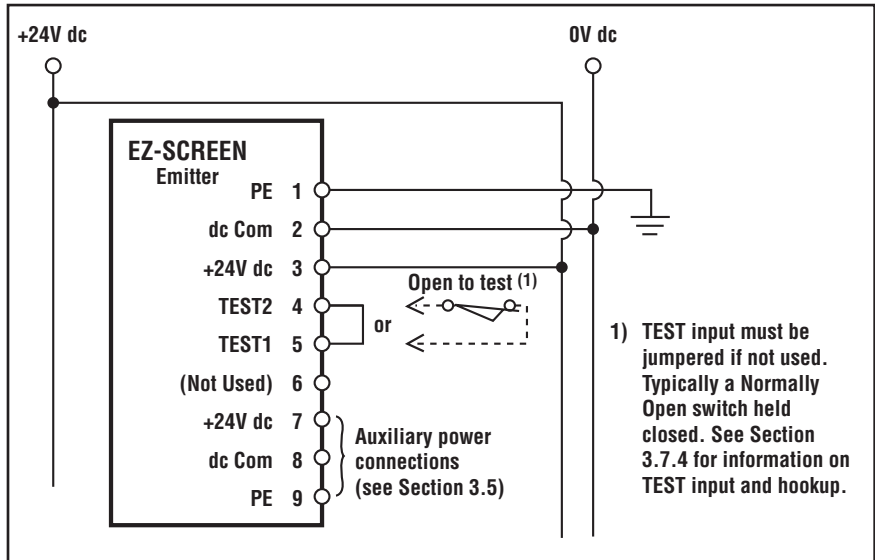

1) TEST input must be jumpered if not used. Typically a Normally Open switch held closed. See Section 3.7.4 for information on TEST input and hookup.

Figure 3-15. EZ-SCREEN emitter generic hookup

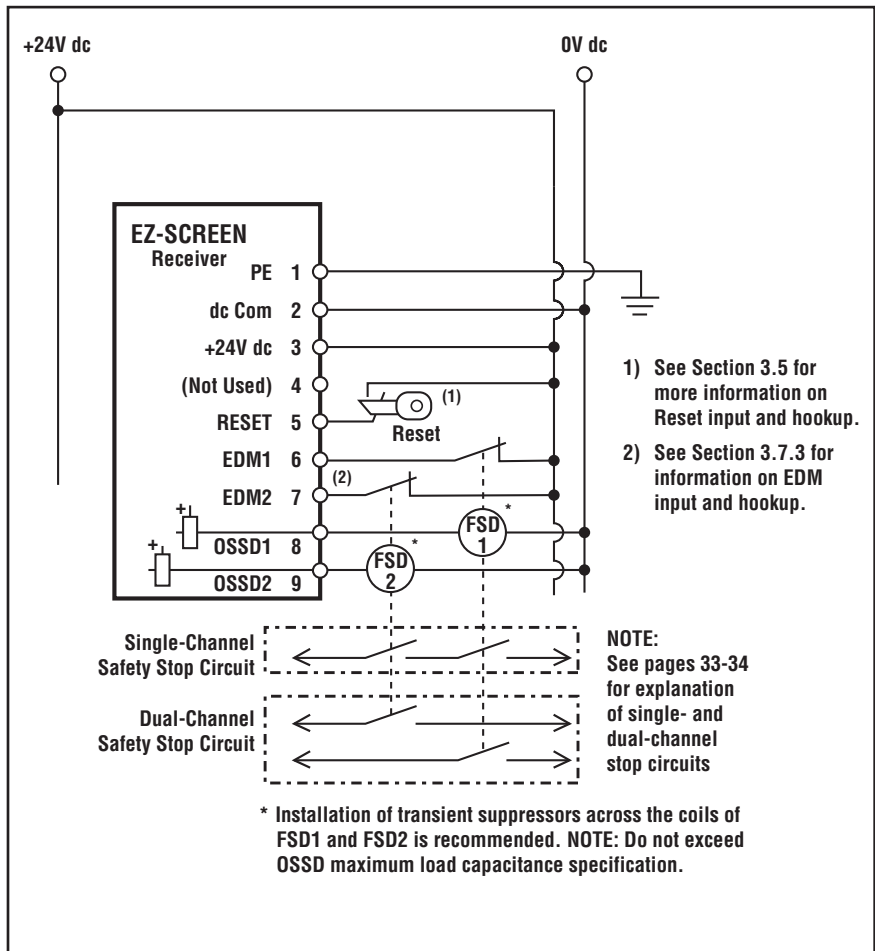

1) See Section 3.5 for more information on Reset input and hookup.
2) See Section 3.7.3 for information on EDM input and hookup.

NOTE:
See pages 33-34 for explanation of single- and dual-channel stop circuits

* Installation of transient suppressors across the coils of FSD1 and FSD2 is recommended. NOTE: Do not exceed OSSD maximum load capacitance specification.

Figure 3-16. EZ-SCREEN receiver generic hookup – FSD (2-channel EDM, key reset)

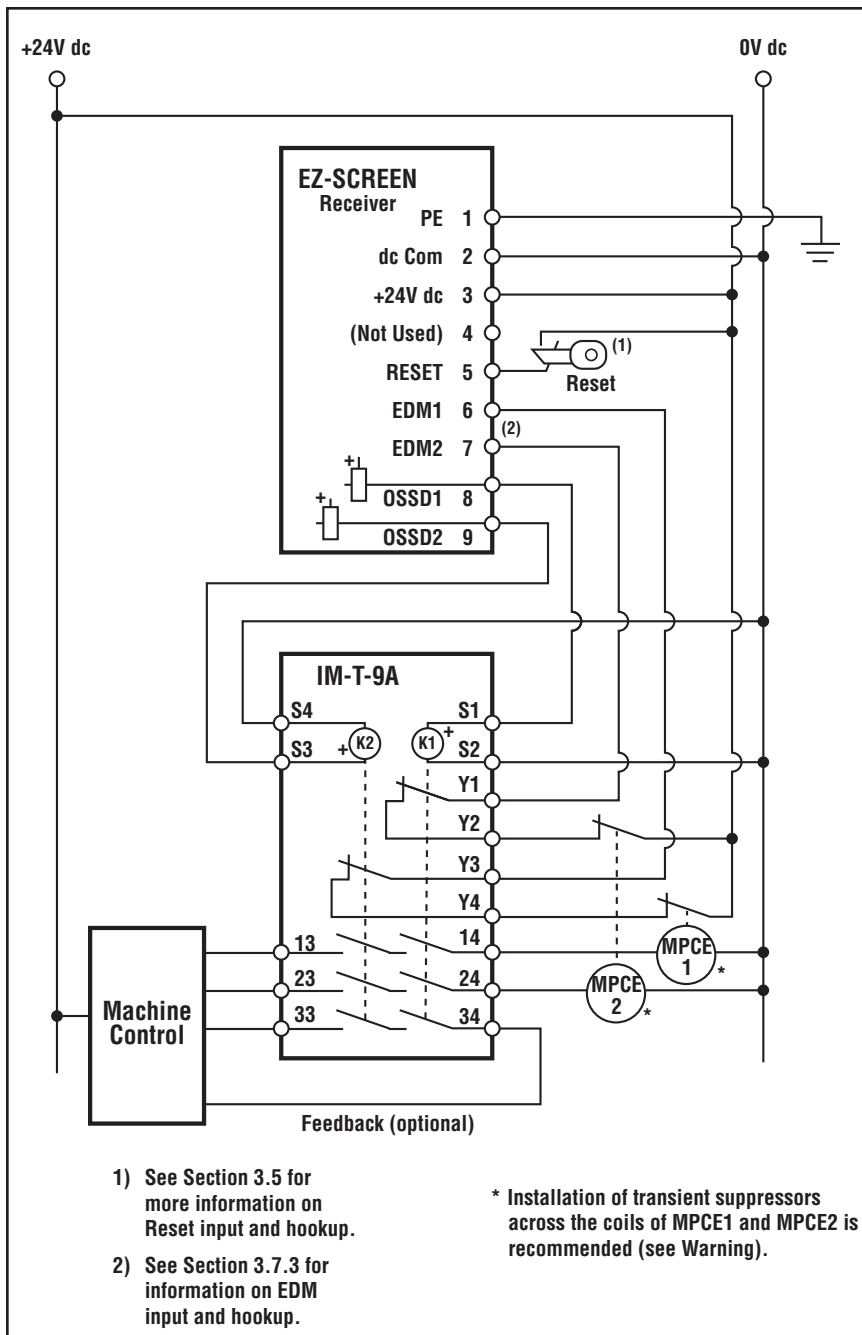

Figure 3-17. EZ-SCREEN receiver generic hookup – interface module (2-channel EDM, key reset)



CAUTION . . . Shock Hazard

Always disconnect all power from the EZ-SCREEN System and the guarded machine before making any connections or replacing any component. Use extreme caution to avoid electrical shock at all times.

Serious bodily injury or death could result.



WARNING . . . Proper Wiring

The generalized wiring configurations shown are provided only to illustrate the importance of proper installation.

The proper wiring of the EZ-SCREEN Grid System to any particular machine is solely the responsibility of the installer and end user.



WARNING . . . Use of Transient Suppressors

If transient suppressors are used, they **MUST** be installed across the coils of the machine control elements. **NEVER** install suppressors directly across the contacts of the IM-T-..A Module! It is possible for suppressors to fail as a short circuit. If installed directly across the contacts of the IM-T-..A Module, a short-circuited suppressor will create an unsafe condition.



WARNING . . . OSSD Interfacing

To ensure proper operation, the EZ-SCREEN OSSD output parameters and machine input parameters must be considered when interfacing the EZ-SCREEN solid-state OSSD outputs to machine inputs.

Machine Control circuitry must be designed so that the maximum load resistance value is not exceeded and that the maximum specified OSSD OFF-state voltage does not result in an ON condition.

Failure to properly interface the OSSD outputs to the guarded machine could result in serious bodily injury or death.

CAUTION . . . Shock Hazard



Always disconnect all power from the EZ-SCREEN System and the guarded machine before making any connections or replacing any component. Use extreme caution to avoid electrical shock at all times.

Serious bodily injury or death could result.

WARNING . . . Proper Wiring



The generalized wiring configurations shown are provided only to illustrate the importance of proper installation.

The proper wiring of the EZ-SCREEN Grid System to any particular machine is solely the responsibility of the installer and end user.

WARNING . . . Use of Transient Suppressors



If transient suppressors are used, they **MUST** be installed across the coils of the machine control elements. **NEVER** install suppressors directly across the contacts of the IM-T-.A Module! It is possible for suppressors to fail as a short circuit. If installed directly across the contacts of the IM-T-.A Module, a short-circuited suppressor will create an unsafe condition.

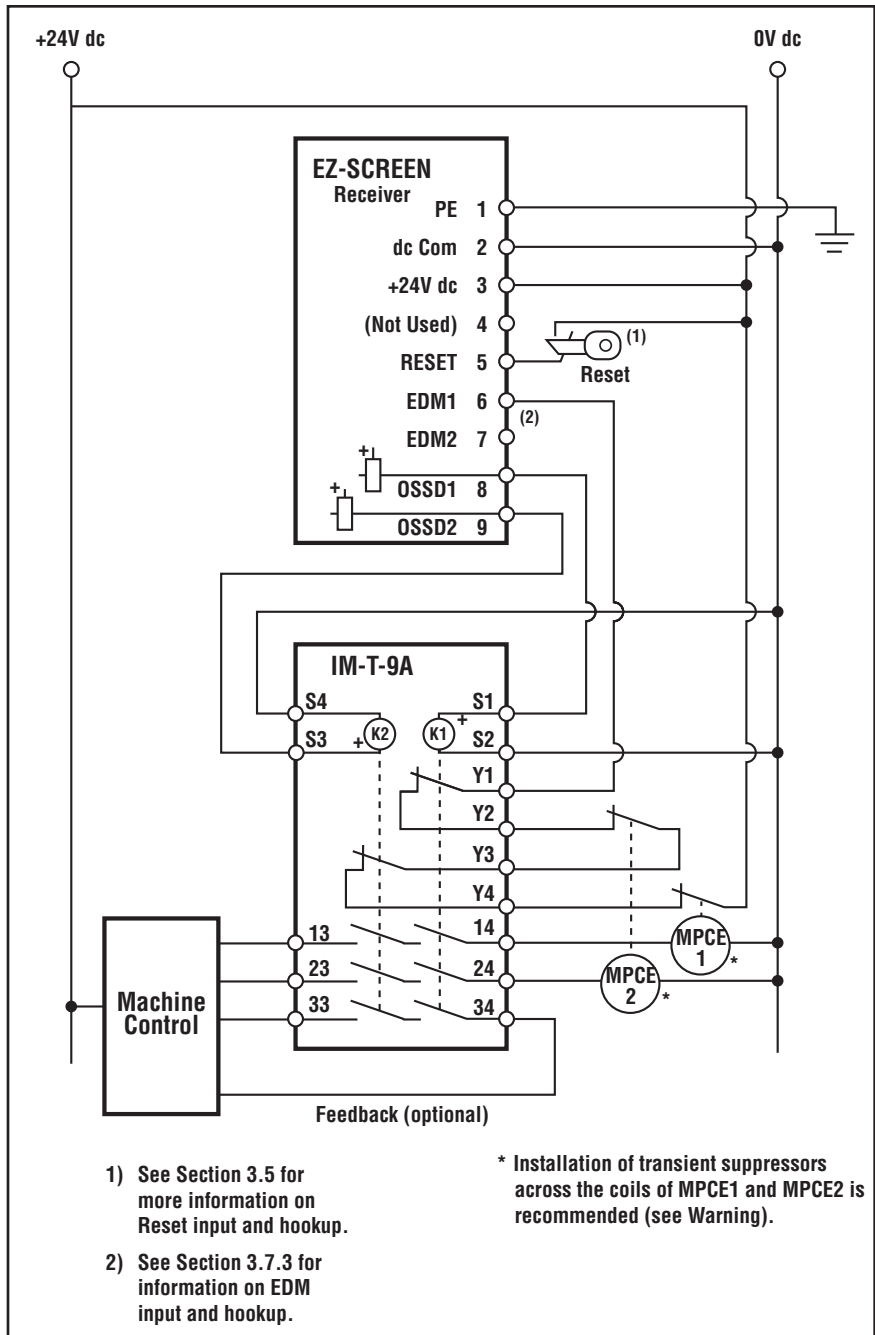



Figure 3-18. EZ-SCREEN receiver generic hookup – interface module (1-channel EDM, key reset)

WARNING . . . OSSD Interfacing



To ensure proper operation, the EZ-SCREEN OSSD output parameters and machine input parameters must be considered when interfacing the EZ-SCREEN solid-state OSSD outputs to machine inputs.

Machine Control circuitry must be designed so that the maximum load resistance value is not exceeded and that the maximum specified OSSD OFF-state voltage does not result in an ON condition.

Failure to properly interface the OSSD outputs to the guarded machine could result in serious bodily injury or death.

4. System Operation

4.1 System Configuration Settings

System configuration settings are made on the configuration panels located on each sensor, behind the threaded access port cap (use the supplied spanner wrench to remove the cap). See Figure 4.1. After configuration settings are verified/set, the access port cap must be fully re-installed to maintain NEMA/IP ratings. **Other than scan code, all configuration settings should be changed only when the system is off.**

NOTE: The corresponding pairs of DIP switches must be set identically for the System to operate.

Scan Code. Scan code is used to allow operation of multiple pairs of emitters and receivers in close proximity (see Section 3.3.7). Scan code may be set to 1 or 2, using the switch on the configuration panel. **The scan code setting for each emitter must agree with its corresponding receiver.** The scan code settings may be changed while in Run mode without causing a lockout.

Trip or Latch Output mode is selected on two DIP switches in the receiver configuration port; see Figure 4.1. Both switches must be set to the same setting. If they have different settings, an error code will be displayed.

If the switches are set for Trip Output mode (T), the system will auto reset. If the switches are set for Latch Output mode (L), the system will require a manual reset.

EDM: EDM mode is selected via two DIP switches in the receiver configuration port; see Figure 4-1. For 1-channel monitoring, set both EDM DIP switches to the 1 position. For 2-channel monitoring or no monitoring, set both EDM DIP switches to the 2 position. See Section 3.7.3 for more information.

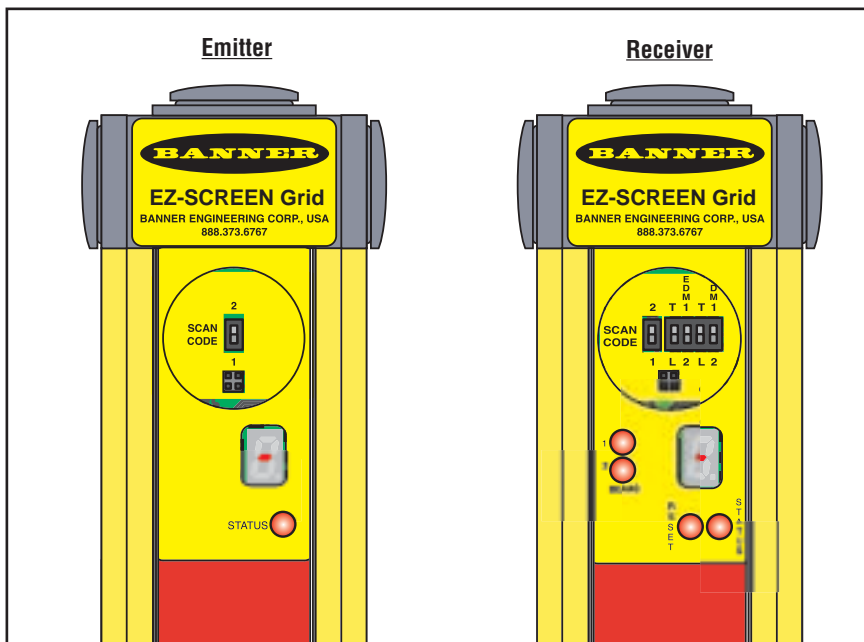

Figure 4-1. EZ-SCREEN Grid configuration switches

4.2 Reset Procedures

4.2.1 Receiver Resets

The EZ-SCREEN Grid receiver has a RESET input, terminal 5, that allows the System to be manually reset. To reset the receiver, close the Reset switch for 1/4 to 2 seconds, then open the Reset switch. (If Reset switch model MGA-KSO-1, listed in Section 2, is used, close the switch by turning the key 1/4 turn clockwise; open it by turning the key counterclockwise, back to its original position.)

NOTE: Closing the Reset switch too long will cause the system to ignore the reset request; the switch must be closed at least 1/4 second, but no longer than 2 seconds.

Receiver manual resets are needed in the following situations:

- **When operating in Trip Output mode**, manual resets are required only after a system lockout (see Section 5 for causes).
- **When the System is in Latch Output mode**, a manual reset is required at power-up, after each latch condition occurs, and after a system lockout.

4.2.2 Emitter Resets

In the rare occurrence that an emitter requires a reset, power the sensor down, then power it up. Emitter resets are needed only if a lockout occurs.

4.3 Status Indicators

A variety of status indicators on both the emitter and the receiver are clearly visible on each sensor's front panel (see Figure 4-1).

Emitter: A single bi-color red/green Status indicator shows whether power is applied, and whether the emitter is in Run mode, Test mode, or Lockout mode. A 7-segment diagnostic display indicates a specific error code when the emitter is in Lockout mode. The 7-segment display also momentarily indicates the scan code setting at power-up or when changed.



Operating Mode	Required Event	Status Indicator	Diagnostic Display	
Power-up	Apply Power	Red Single Flash	Scan code flash 3x (C1 or C2)	
Run Mode	Passes Internal Tests	Green	Dash	
Test Mode	Open Test Switch	Flashing Green	Dash	
Lockout Mode	Internal/External Fault	Flashing Red	Displays Error Code	*

Figure 4-2. Emitter status indicators and operation

* See Section 5.1 for a description of error codes

Receiver: A bi-color red/green Beam Status indicator for each beam shows whether that beam is aligned and clear with a strong signal, clear but with a weak signal, or is blocked and/or misaligned. A yellow Reset indicator shows when the system is in Run mode or is waiting for a reset. A bi-color red/green Status indicator shows when the OSSD outputs are ON (green) or OFF (red), or the system is in lockout mode (flashing red). A 7-segment diagnostic display indicates the receiver's Trip (-) or Latch (L) configuration setting and displays a specific error code when the receiver is in lockout. The 7-segment display also momentarily indicates the scan code setting at power-up or when changed.

NOTE: If beam 1 is blocked, all other Beam Status indicators will be OFF, because beam 1 provides the synchronization signal for all the beams.





Operating Mode	Required Event	Reset Indicator	Status Indicator	Beam Status Indicators	Diagnostic Display	OSSD Outputs
Power-up	Apply Power	Off	Single-Flash Red	All Single-Flash Red	Scan code flash 3x (C1 or C2)	Off
Alignment Mode – Beam 1 Blocked	Passes Internal Tests	Off	Off	Beam 1 Red ⁽¹⁾ Others Off	Off	 Off
Alignment Mode – Beam 1 Clear	Align Beam 1	Off	Off	Beam 1 Green ⁽²⁾ Others Red or Green ⁽²⁾	Off	 Off
Run Mode – Clear	Align All Beams	On	On Green	All On Green ⁽²⁾	Dash	 On
Run Mode – Blocked	Beam(s) Blocked	On	Red	Red or Green ^{(1), (2)}	Dash	 Off
Lockout Mode	Internal/External Fault	Off	Flashing Red	All Off	Displays Error Code	* Off

Figure 4-3a. Receiver status indicators and operation (Trip Output mode)

* See Section 5.1 for a description of error codes







Operating Mode	Required Event	Reset Indicator	Status Indicator	Beam Status Indicators	Diagnostic Display	OSSD Outputs
Power-up	Apply Power	Off	Single-Flash Red	All Single-Flash Red	Scan code flash 3x (C1 or C2)	Off
Alignment Mode – Beam 1 Blocked	Passes Internal Tests	Off	Off	Red ⁽¹⁾	Off	 Off
Alignment Mode – Beam 1 Clear	Align Beam 1	Off	Off	Beam 1 Green ⁽²⁾ Others Red or Green ⁽²⁾	Off	 Off
Alignment Mode – All Beams Clear	Align All Beams	Double-Flash	Off	All On Green ⁽²⁾	Off	 Off
Run Mode – Clear	Perform Reset	On	Green	All On Green ⁽²⁾	“L”	 On
Latched – Blocked	Block 1 or More Beams	On	Red	Red or Green ^{(1), (2)}	“L”	 Off
Latched – Clear	Clear All Beams	Flashing	Red	All On Green ⁽²⁾	“L”	 Off
Lockout Mode	Internal/External Fault	Off	Flashing Red	Off	Displays Error Code	* Off

Figure 4-3b. Receiver status indicators and operation (Latch Output mode)

* See Section 5.1 for a description of error codes

Notes:

(1) If beam 1 is blocked, all other beam indicators will be off.

(2) Flashing Green indicates a clear but weak signal.

4.4 Normal Operation

System Power-Up

The System will power up in one of two ways, depending on the Trip/Latch output configuration. If the System is set for Trip output, it will power up and reset automatically; if the System is set for Latch output, it will require a manual reset procedure after power-up and sensor alignment.

Trip Output Mode Power-Up: When power is applied, each sensor will conduct self-tests to detect critical internal faults, determine configuration settings, and prepare the System for operation. (If either sensor detects a critical fault, scanning ceases, the receiver outputs remain OFF and diagnostic information is displayed through the sensor's front window.) If no faults are detected, the System will automatically enter Alignment mode, with the receiver looking for an optical sync pattern from the emitter. If the receiver is aligned and receiving the proper sync pattern, it enters Run mode and begins scanning to determine the blocked or clear status of each beam. No manual reset operation is required.

Latch Output Mode Power-Up: When power is applied, each sensor will conduct self-tests to detect critical internal faults, determine configuration settings, and prepare the System for operation. (If either sensor detects a critical fault, scanning ceases, the receiver outputs remain OFF and diagnostic information is displayed through the sensor's front window.) If no faults are detected, the System will automatically enter Alignment mode, with the receiver looking for an optical sync pattern from the emitter. If the receiver is aligned and receiving the proper sync pattern, it begins scanning to determine the blocked or clear status of each beam. When all beams are aligned, the Yellow Reset indicator will double-flash to indicate the System is waiting for a manual reset. After a valid manual reset, the System enters Run mode and continues scanning.

During RUN Mode

Trip Output Configuration: If any beams become blocked while the System is running with Trip output mode selected, the receiver outputs turn OFF within 24 ms (the maximum System response time). If all the beams then become clear, the receiver outputs come back ON. No resets of any kind are needed. All required machine control resets are provided by the machine control circuit.

Latch Output Configuration: If any beams become blocked while the System is running with Latch mode selected, the receiver outputs turn OFF within 24 ms. If all the beams then become clear, the receiver Beam Status indicators will all be Green and the Reset indicator will single-flash, indicating the System is waiting for a manual latch reset. In Latch output mode, the outputs come back ON *only when all beams are clear and after a manual reset*. The System will wait for a manual reset; when a valid reset signal is received and all beams remain clear, the receiver outputs turn ON. To perform a manual reset, close the Reset switch for 1/4 to 2 seconds, then open the switch. (For switch model MGA-KS0-1, described in Section 2, turn the key 1/4 turn clockwise, hold for 1/4 to 2 seconds, then turn the key counterclockwise to its original position.)

Internal Faults (Lockouts): If either sensor detects a critical fault, scanning ceases, the receiver outputs turn OFF and diagnostic information is displayed through the sensor's front window. See Section 5 for resolution of error/fault conditions.

4.5 Periodic Checkout Requirements

To ensure continued reliable operation, the System should be checked out periodically.

At every shift change, power-up and machine setup change, the Daily checkout should be performed; this checkout may be performed by a Designated or Qualified Person (see Section 6.4 for the procedure).

Semi-annually, the system and its interface to the guarded machine should be thoroughly checked out; this checkout must be performed by a Qualified Person (see Section 6.5). A copy of these test results should be posted on or near the machine.

Whenever changes are made to the System (either a new configuration of the EZ-SCREEN System or changes to the machine), the Commissioning Checkout should be performed (see Section 6.3).

5. Troubleshooting and Maintenance

Evaluate status indicators per Section 4.3.

5.1 Troubleshooting Lockout Conditions

A lockout condition causes all of the EZ-SCREEN OSSD outputs to turn or remain OFF, sending a “stop” signal to the guarded machine. Each sensor provides diagnostic error codes to assist in the identification of the cause(s) of Lockouts (see Figure 5-1).

The System provides easy methods for determining operating problems. A Lockout condition is indicated by the following:

Emitter	
Status indicator	Flashing red
Diagnostic display	Error code
Receiver	
Reset indicator	OFF
Status indicator	Flashing red
Beam Status indicators	OFF
Diagnostic display	Error code

Recovery Procedures

To recover from a Lockout condition, all errors must be corrected and sensor resets must be performed as shown below.

NOTE: An emitter reset is only required if the emitter is in a Lockout condition.

Receiver Reset

Close the receiver Reset switch for 1/4 to 2 seconds and then open the switch (per Section 4.2) or power the sensor down, wait a second or two, then power it up.

NOTE: If the power down/up method is used and the system is set for Latch mode, a manual reset, as described in Section 4.4, is required to resume full operation.

Emitter Reset:

Power the sensor down, wait a second or two, and then power it up.

5.1.1 Receiver Error Codes

Refer to Figure 5-1 for a full description of receiver error codes and what to do when they occur.





Diagnostic Display	Error Description	Appropriate Action
	<p>Output Error Error is caused by:</p> <ul style="list-style-type: none"> • one or both outputs being shorted to a power supply (high or low), • by shorting OSSD 1 to OSSD 2, or • by an overload (greater than 0.5A). 	<ul style="list-style-type: none"> • Disconnect the OSSD loads and reset the receiver. • If the error clears, the problem is in the OSSD load(s) or in the load wiring. • If the error continues with no load connected, replace the receiver.
	<p>Reset Input Error This error occurs when the Reset switch is closed (or the wiring is shorted to +24V) during power-up.</p>	<ul style="list-style-type: none"> • Verify that the Reset switch is in the open position. • Reset the receiver per Section 4.2. • If the error remains, disconnect the reset wire at terminal 5; remove and reapply input power. • If the error clears, the problem is in the Reset switch or in the wiring. • If the error continues when the reset wire is disconnected, replace the receiver.
	<p>EDM Input Error Can occur for the following reasons:</p> <ul style="list-style-type: none"> • EDM wiring configuration does not match the EDM switch configuration. • No connection to EDM terminals. • <i>Both</i> EDM inputs fail to respond within 200 ms of the OSSDs changing state (ON or OFF). • Excessive noise on EDM inputs. 	<ul style="list-style-type: none"> • Verify that the EDM configuration switches are set correctly and that the wiring is correct for the EDM type configured (see Section 3.7.3). • Reset the receiver. • If the error continues, remove power to the guarded machine, disconnect the OSSD loads, disconnect the EDM input signals, configure EDM for No Monitoring (Section 3.7.3) and conduct the Initial Checkout procedure in Section 3.6. • If the error clears, the problem is in the external device contacts or wiring, or is a response-time problem of the external devices. Check to see that the EDM wiring is correct and that the external devices meet the requirements described in Section 3.7.3. • If the error continues, check for excessive noise on the EDM inputs (see Section 5.2). • If the error continues after verifying electrical noise is not present, replace the receiver.
	<p>Receiver Error This error can occur due to either excessive electrical noise or an internal failure.</p>	<ul style="list-style-type: none"> • Perform a reset per Section 4.2. • If the error clears, perform a Daily Checkout procedure (per Section 6.4) and if OK, resume operation. If the system fails the Daily Checkout procedure, replace the receiver. • If the error continues, check the ground connection (terminal 1). • If the sensor has a good earth ground connection to terminal 1, perform the Initial Checkout procedure (per Section 3.6). • If the error clears, check the external connections and configuration settings. • If the error continues, replace the receiver.
	<p>Excessive Noise Error This error can occur due to excessive levels of electrical noise.</p>	<ul style="list-style-type: none"> • Perform a reset per Section 4.2. • If the error clears, perform a Daily Checkout procedure (per Section 6.4) and if OK, resume operation. If the system fails the Daily Checkout procedure, replace the receiver. • If the error continues, check the ground connection (terminal 1). • If the sensor has a good earth ground connection to terminal 1, perform the Initial Checkout procedure (Section 3.6). • If the error clears, check for sources of electrical noise (see Section 5.2). • If the error continues when performing the Initial Checkout procedure, replace the receiver.

Figure 5-1a. Receiver error codes



Diagnostic Display	Error Description	Appropriate Action
	<p>DIP Switch Error This error can be caused by incorrect DIP switch settings or by changes to the DIP switch settings when the system is on.</p>	<ul style="list-style-type: none"> • Verify that the DIP switch settings are valid (per Section 4.1). Make any corrections necessary and perform a receiver reset. • If the error occurred due to a change of the DIP switch settings while the system was in RUN mode, verify the switch settings and perform a receiver reset to resume operation with the new switch settings and modified system configuration. • If the error continues, replace the receiver.
	<p>EDM 1 Error This error can occur due to EDM 1 input signal failing to respond within 200 ms of OSSD 1 changing state (ON or OFF) or by EDM 1 input signal changing state when OSSD 1 did not change or by excessive noise on EDM 1 input.</p>	<ul style="list-style-type: none"> • Check to see that the EDM wiring is correct and that the external devices meet the requirements described in Section 3.7. • If the error continues, remove power to the guarded machine, disconnect the OSSD loads, disconnect the EDM input signals, configure EDM for No Monitoring (per Section 3.7.3) and conduct the Initial Checkout procedure in Section 3.6. • If the error clears, the problem is in the External Device contacts or wiring, or is a response-time problem of the external devices. Check to see that the EDM wiring is correct and that the external devices meet the requirements described in Section 3.7. • If the error continues, check for excessive noise on the EDM inputs (see Section 5.2).
	<p>EDM 2 Error This error can occur due to EDM 2 input signal failing to respond within 200 ms of OSSD 2 changing state (ON or OFF), or by the EDM 2 input signal changing state when OSSD 2 did not change, or by excessive noise on EDM 2 input.</p>	<ul style="list-style-type: none"> • Check to see that the EDM wiring is correct and that the external devices meet the requirements described in Section 3.7. • If the error continues, remove power to the guarded machine, disconnect the OSSD loads, disconnect the EDM input signals, configure EDM for No Monitoring (per Section 3.7.3) and conduct the Initial Checkout procedure (Section 3.6). • If the error clears, the problem is in the External Device contacts or wiring, or is a response-time problem of the external devices. Check to see that the EDM wiring is correct and that the external devices meet the requirements described in Section 3.7. • If the error continues, check for excessive noise on the EDM inputs (see Section 5.2).

Figure 5-1b. Receiver error codes, continued

5.1.2 Emitter Error Codes

NOTE: The emitter flashes the number 2 followed by the other error code digit, pauses, then flashes the sequence again.



Diagnostic Display	Error Description	Cause of Error
	<p>Test Input Error This error can occur if excessive noise is present on the test input.</p>	<ul style="list-style-type: none"> Reset the emitter by disconnecting and reapplying power to the emitter (see Section 4.2). If the error clears, perform a Daily Checkout procedure (Section 6.4) and if OK, resume operation. If the system fails the Daily Checkout procedure, replace the emitter. If the error continues, check the ground connection (terminal 1). If the sensor has a good earth ground connection to terminal 1, check for noise on the test input wiring (see Sections 5.2 and 5.3).
	<p>Emitter Error This error can occur either due to excessive electrical noise or due to an internal failure.</p>	<ul style="list-style-type: none"> Reset the emitter by disconnecting and reapplying power to the emitter (see Section 4.2). If the error clears, perform a Daily Checkout procedure (Section 6.4) and if OK, resume operation. If the system fails the Daily Checkout procedure, replace the emitter. If the error continues, check the ground connection (terminal 1). If the sensor has a good earth ground connection to terminal 1, check for electrical noise (see Section 5.2). If the error continues, replace the emitter.
	<p>Excessive Noise Error This error can occur due to excessive electrical noise.</p>	<ul style="list-style-type: none"> Reset the emitter by disconnecting and reapplying power to the emitter (see Section 4.2). If the error clears, perform a Daily Checkout procedure (Section 6.4) and if OK, resume operation. If the system fails the Daily Checkout procedure, replace the emitter. If the error continues, check the ground connection (terminal 1). If the sensor has a good earth ground connection to terminal 1, check for electrical noise (see Section 5.2). If the error continues, replace the emitter.

Figure 5-2. Emitter error codes



WARNING . . .
Shut Down Machinery
before Servicing

The machinery connected to the EZ-SCREEN Grid System must not be operating at any time during this procedure. Some servicing procedures may involve working close to the hazardous areas of the guarded machine.

Serious bodily injury or death could result.



CAUTION . . .
Electrical Danger

Exercise care whenever troubleshooting, repairing, or modifying the EZ-SCREEN System and/or the machine control system. Always disconnect all power from the EZ-SCREEN Grid System and the guarded machine before making any wire connections or before replacing any component.

Electrical connections or repairs should be done only by a Qualified Person (see Safety Glossary).



WARNING . . .
Power Failures and
Lockouts

A lockout is a definite indication of a problem and should be investigated at once, by a Qualified Person.

Attempts to continue to operate machinery by bypassing the EZ-SCREEN Grid System are dangerous and could result in serious bodily injury or death.

5.2 Electrical and Optical Noise

The EZ-SCREEN System is designed and manufactured to be highly resistant to electrical and optical noise and to operate reliably in industrial settings. However, serious electrical and/or optical noise may cause a random trip or latch condition. In very extreme electrical noise cases, a lockout is possible. In order to minimize the effects of transitory noise, the EZ-SCREEN System will respond to noise only if the noise is detected on multiple consecutive scans.

If random nuisance trips occur, check the following:

- Poor connection between the sensor and earth ground;
- Optical interference from adjacent light grids or other photoelectrics; or
- Sensor input or output wires routed too close to “noisy” wiring.

Checking for sources of electrical noise: It is very important that the light grid sensors have a good earth ground. Without this, the system can act like an antenna and random trips and lockouts can occur.

All EZ-SCREEN System wiring is low voltage; running these wires alongside power wires, motor/servo wires, or other high-voltage wiring, can inject noise into the EZ-SCREEN system. It is good wiring practice (and may be required by code) to isolate EZ-SCREEN System wires from high-voltage wires.

The Banner BT-1 Beam Tracker is a very good tool for detecting electrical noise. It can be used to detect electrical transient spikes and surges. Cover the lens of the BT-1 with electrical tape to block optical light from getting into the receiver lens. Press the “RCV” button on the BT-1 and position the Beam Tracker on the wires going to the EZ-SCREEN or any other nearby wires. Noise caused by the switching of inductive loads should be addressed by installing proper transient suppression across the load.

Checking for sources of optical noise:

Turn off the emitter, completely block the emitter beams, or open the Test input, then use a Banner BT-1 Beam Tracker to check for light at the receiver. Press the “RCV” button on the BT-1 and move it across the full length of the receiver’s sensing window. If the BT-1’s indicator lights, check for light from other sources (other safety light screens, grids or points, or standard photoelectric sensors) by “tracking down” the emitted light from them.

5.3 Test Mode

Opening a switch or relay contacts connected to the TEST1 and TEST2 terminals of the emitter, or supplying a voltage of less than 3V dc to TEST1 only, simulates a blocked condition, for testing purposes.

To verify proper operation, measure the voltage between TEST1 (terminal 5) and dc COM (terminal 2 or 8) of the emitter:

- If the voltage is 10 to 30V dc, the emitter should be in Run mode and beam scanning should be occurring. If not, check the +24V dc (terminal 3) to verify proper supply voltage. If the supply voltage is not within the rated supply voltage specifications, correct the supply voltage and recheck emitter operation. If the supply voltage is correct, TEST1 is 10 to 30V dc and the emitter does not operate properly (Run mode with beam scanning). Replace emitter.
- If the voltage is less than 3V dc, the emitter should be in Test mode and no scanning should be occurring. If not in Test mode, replace emitter.

5.4 Servicing and Maintenance

Cleaning

EZ-SCREEN System emitters and receivers are constructed of aluminum with a yellow painted finish and are rated NEMA 4, 13 (IP65). Lens covers are acrylic. Emitters and receivers are best cleaned using mild detergent or window cleaner and a soft cloth. Avoid cleaners containing alcohol, as they may damage the acrylic lens covers.

The accessory interface module is constructed of polycarbonate and is rated NEMA 1 (IP20). It may be dusted, but avoid contact with any liquids.

Warranty Service

The EZ-SCREEN System is designed for reliability. Do not open the emitter or receiver housings, other than to access the configuration port or to make terminal connections. Do not open the housing of the interface module, if used. They contain no field-replaceable components. If repair is necessary, do not attempt to repair an emitter, receiver, or interface module yourself; return the unit to the factory.

If it ever becomes necessary to return a system component to the factory, please do the following:

- 1) Contact the Banner Factory Application Engineering group at the address or numbers listed below:

Banner Engineering Corp., Application Engineering Group
9714 Tenth Avenue North
Minneapolis, MN 55441
Phone: 763.544.3164 or
Toll-Free (US only): 888.373.6767
email: sensors@bannerengineering.com

They will attempt to troubleshoot the system from your description of the problem. If they conclude that a component is defective, they will issue an RMA (Return Merchandise Authorization) number for your paperwork, and give you the proper shipping address.

- 2) Pack the component(s) carefully. Damage which occurs during return shipping is not covered by warranty.

6. Periodic Checkout Procedures

Study each procedure from beginning to end before you start to make sure that you understand each step. Refer all questions to the Banner Applications Engineering Department at the address or numbers listed on the front cover of this manual. Checkouts must be performed as detailed in Section 6.1 below and results should be recorded and kept in the appropriate place (e.g., near the machine, and/or in a technical file).

6.1 Schedule of Checkouts

Initial Checkout: The procedure for initial checkout of the EZ-SCREEN Grid System is described in Section 3.6. This procedure is performed at installation, and at any time the System, the guarded machine, or any part of the application is installed or altered. The procedure must be performed by a Qualified Person.

Commissioning Checkout: Should be performed at installation or whenever changes are made to the system (either a new configuration of the EZ-SCREEN System or changes to the machine). The procedure must be performed by a Qualified Person.

Daily Checkout: The procedure for “daily” checkout of the EZ-SCREEN Grid System is to be performed at each shift change or machine setup change, whenever the System is powered up, at least daily. The procedure may be performed by a Designated Person or a Qualified Person.

Semi-Annual Checkout: The procedure for initial checkout of the EZ-SCREEN Grid System is to be performed at every six months, following installation of the System. The procedure must be performed by a Qualified Person.

6.2 Trip Test

Once all Beam Status indicators are steady Green, trip test the Light Grid System to verify proper system operation and to detect possible reflection problems, using the test piece included with the System. With power ON:

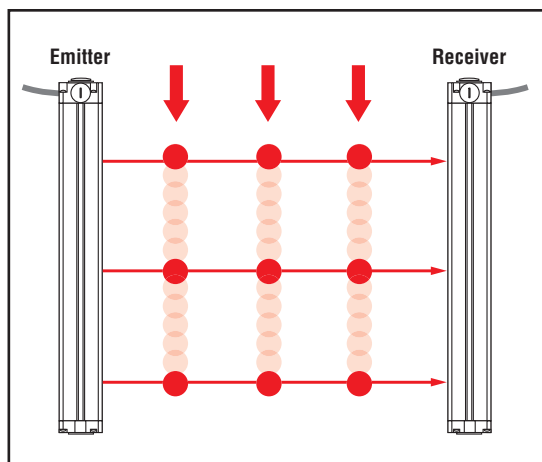

Figure 6-1. EZ-SCREEN Grid trip test

- 1) Verify that the EZ-SCREEN Grid System is in Run mode; receiver status indicators should be as follows:

Status indicator	Green
All Beam Status indicators	Green
Reset indicator	ON
Diagnostic Display	“_” (Trip Output mode) or “L” (Latch Output mode)
- 2) Pass the test piece downward through each beam at three points: near the receiver, near the emitter, and midway between them. In each case, verify that the appropriate Beam Status indicator on the receiver turns steady Red and remains steady Red while the test piece is blocking the beam. Also, verify that the Status indicator is steady Red while any or all beams are blocked. If the emitter and receiver are far apart, a second person may be needed to monitor the indicators while the test piece is used near the emitter or in the midway position.

NOTE: If beam 1 is blocked, all other Beam Status indicators will be OFF, because beam 1 provides the synchronization signal for all the beams.

If mirrors are used in the application: Test the grid at three points *on each leg* of the beam path (emitter to mirror, between mirror and receiver). See Figure 6-2.

Verify that the appropriate Beam Status indicator turns Green when the blockage is removed from each beam.

NOTE: When blocking the first beam, all other beam indicators will be OFF, because the first beam provides the synchronization signal for all the beams.

If the appropriate Beam Status indicator remains steady Green or flickers while the test piece is blocking the beam, check for the presence of reflective surfaces; see Section 3.3.4. **Do not continue or operate the guarded machine until the situation is corrected and the indicator turns steady Red whenever the test piece is in the beam path.**

To eliminate the problem reflections:

- **If possible, relocate the sensors** to move the light grid beams away from the reflective surface(s), being careful to maintain adequate separation distance.
- **Otherwise, if possible, paint, mask or roughen the surface** to reduce the reflectivity.
- **Where these are not possible (as with a shiny workpiece),** include a means of restricting the receiver's field of view or the emitter's spread of light in the sensor mounting.
- **Repeat the trip test** to verify that these changes have eliminated the problem reflection(s). If the workpiece is especially reflective and comes close to the light grid, perform the trip test with the workpiece in place.

When the test piece is removed, verify that all of the Beam Status indicators on the receiver are steady Green. If any indicator is flickering, the signal is weak; first clean the lenses. If this does not correct the problem, realign the sensors as needed (see Section 3.6). If the System is operating in Latch Output mode, perform a manual receiver reset. Verify that the receiver Status indicator is steady Green.

Do not continue operation until the entire checkout procedure is complete and all problems are corrected.



WARNING . . .
If Trip Test Indicates a Problem

If the EZ-SCREEN Grid System does not respond properly to the Trip Test, do not attempt to use the System. If this occurs, the System cannot be relied upon to stop dangerous machine motion when a person or object enters the light grid.

Serious bodily injury or death could result.

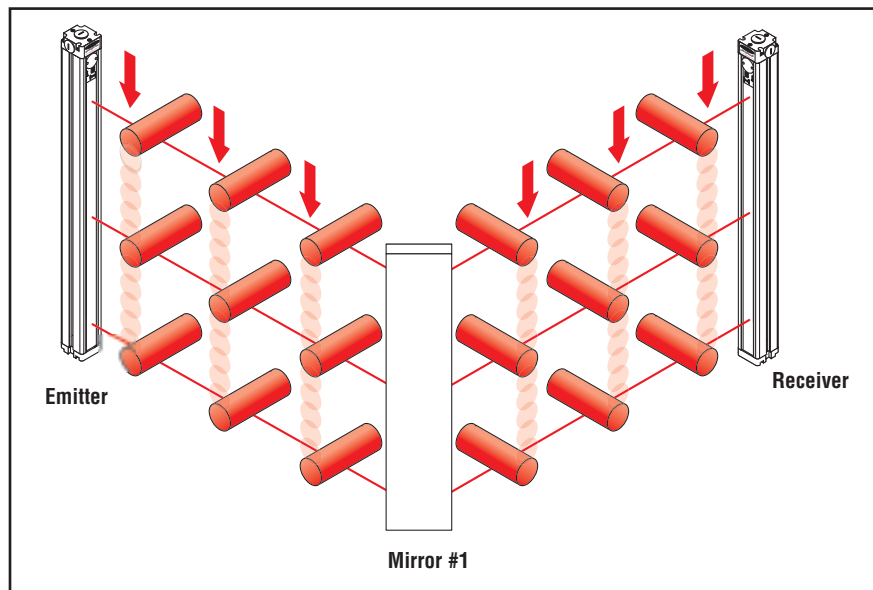

Figure 6-2. EZ-SCREEN Grid trip test with corner mirrors

6.3 Commissioning Checkout

Perform this checkout procedure as part of System installation (after the System has been interfaced to the guarded machine as described in Section 3.7), or whenever changes are made to the System (either a new configuration of the EZ-SCREEN System or changes to the machine). A Qualified Person (as defined in the Safety Glossary) must perform the procedure; checkout results should be recorded and kept on or near the guarded machine, per OSHA 1910.217(e)(1).

To prepare the System for this checkout, set the System configuration as it will be during machine operation.

- 1) Examine the guarded machine to verify that it is of a type and design compatible with the EZ-SCREEN Grid System. See page 2 for a list of misapplications.
- 2) Verify that the minimum separation distance from the closest danger point of the guarded machine to the Safety Light Grid is not less than the calculated distance, per Section 3.3.1 of this manual.
- 3) Verify that
 - Access to any dangerous parts of the guarded machine is not possible from any direction not protected by the EZ-SCREEN Grid System, hard guarding, or supplemental safeguarding, and
 - It is not possible for a person to stand between the Safety Light Grid and the dangerous parts of the machine, or
 - Supplemental safeguarding and hard guarding, as described by the appropriate safety standards, are in place and functioning properly in any space (between the Safety Light Grid and any hazard) which is large enough to allow a person to stand undetected by the EZ-SCREEN Grid System.
- 4) Verify that the Reset switch is mounted outside the guarded area, out of reach of anyone inside the guarded area, and that the key or other means of preventing inadvertent use is in place.
- 5) Examine the electrical wiring connections between the EZ-SCREEN Grid System OSSD outputs and the guarded machine's control elements to verify that the wiring meets the requirements stated in Section 3.7.
- 6) Inspect the area near the light grid (including work pieces and the guarded machine) for reflective surfaces. (Reflective surfaces may cause System beams to reflect around a person in the light grid, preventing the person from being detected and not stopping the machine motion.) Remove the reflective surfaces as possible by relocating them, painting, masking or roughening them. Remaining problem reflections will become apparent during step 10.
- 7) Apply power to the EZ-SCREEN Grid System. Ensure that power to the guarded machine is OFF. Remove all obstructions from the light grid. If the System is configured for Latch mode, the receiver Reset indicator will be double-flashing. Perform a manual reset (close the Reset switch for 1/4 to 2 seconds, then open the switch). Verify that the Reset indicator is ON steady.

- 8) Observe the receiver 7-segment display to verify that the system is set to the desired operating mode (Trip Output - “-”; Latch - “L”).

Observe the status indicators on the receiver to determine light grid status:

A blocked condition is indicated by the Status indicator steady Red, and one or more Beam Status indicator(s) steady Red.

NOTE: If beam 1 is blocked, all other beam indicators will be OFF, because beam 1 provides the synchronization signal for all the beams.

A clear condition is indicated by all Beam Status indicators steady Green. (Beam Status indicators will flicker Green if excess gain is marginal.)

A latch condition is indicated by the receiver Status indicator steady Red. Beam Status indicators may be Red, Green, or flashing Green, depending on the status of each beam. In Latch mode, the outputs come back ON *only when all beams are clear and after a manual reset.*

A lockout condition is indicated by the Status indicator single-flashing Red, and the Reset indicator OFF.

- 9) If in a clear condition, go to step 10. If in a lockout condition, refer to Section 5. A blocked condition indicates that one or more of the beams is misaligned or interrupted. To correct this situation:
- Check carefully for any obstruction in the path of the beam(s).
 - Check for contamination. Clean the emitter and receiver windows as required (see Section 5.4).
 - If the light grid is completely clear of obstructions, realign the emitter and receiver, as described in Section 3.6.

If the system is in a latch condition, perform a manual reset.

- 10) Once the System Status indicator and all Beam Status indicators are steady Green, **perform the trip test** (described in Section 6.2) to verify proper system operation and to detect possible reflection problems.
- 11) Apply power to the guarded machine and verify that the machine does not start up. Block one of the grid beams and verify that it is not possible for the guarded machine to be put into motion while the beam is blocked.
- 12) Initiate machine motion of the guarded machine and, while it is moving, use the supplied test piece to block one of the grid beams. Do not attempt to insert the test piece into the dangerous parts of the machine. Upon blocking any beam, the dangerous parts of the machine should come to a stop with no apparent delay. Upon removal of the test piece from the beam, verify that **the machine does not automatically restart**, and that the initiation devices must be engaged to restart the machine.
- 13) Remove electrical power to the EZ-SCREEN Grid System. All OSSD outputs should immediately turn OFF, and should not be capable of turning ON until power is re-applied and, if in Latch Output mode, a manual reset is performed (Trip Output mode requires no manual reset).
- 14) Test the machine stopping response time, using an instrument designed for that purpose, to verify that it is the same or less than the overall system response time specified by the machine manufacturer. (Banner’s Applications Engineering Department can recommend a suitable instrument.)

Do not continue operation until the entire checkout procedure is complete and all problems are corrected.



WARNING . . .
Do Not Use Machine Until System Is Working Properly

If all of these checks cannot be verified, do not attempt to use the EZ-SCREEN System/guarded machine until the defect or problem has been corrected (see Section 5).

Attempts to use the guarded machine under such conditions could result in serious bodily injury or death.



WARNING . . .
Before Applying Power to the Machine

Verify that the guarded area is clear of personnel and unwanted materials (such as tools) before applying power to the guarded machine.

Failure to do so could result in serious bodily injury or death.

6.4 Daily Checkout

Perform this checkout procedure at every shift change, power-up and machine set-up change. During continuous machine run periods, this checkout must be performed at intervals not to exceed 24 hours. A Designated Person or Qualified Person (as defined in the Safety Glossary) must perform the procedure; checkout results should be recorded and kept on or near the guarded machine, per OSHA 1910.217(e)(1).

- 1) Verify that access to the guarded area is not possible from any area not protected by the EZ-SCREEN Grid System. Hard guarding, or supplemental presence-sensing devices must be installed, wherever needed, to prevent any person from reaching around the light grid or entering into the hazard area. Verify that all supplemental guarding devices and hard guarding are in place and operating properly.
- 2) Verify that the minimum separation distance from the closest danger point of the guarded machine to the light grid is not less than the separation distance calculated in Section 3.3.1 and recorded here: _____.
- 3) Verify that it is not possible for a person to stand within the guarded area, undetected by the EZ-SCREEN Grid System or by other supplemental guarding (as described in ANSI/RIA R15.06, or other appropriate standards).
- 4) Verify that the Reset switch is mounted outside the guarded area, out of reach of anyone inside the guarded area, and that the key or other means of preventing inadvertent use is in place.
- 5) Test the effectiveness of the EZ-SCREEN Grid System with power ON, using the trip test (Section 6.2).
- 6) Initiate machine motion of the guarded machine and, while it is moving, use the supplied test piece to block one of the grid beams. Do not attempt to insert the test piece into the dangerous parts of the machine. Upon blocking any beam, the dangerous parts of the machine should come to a stop with no apparent delay. Upon removal of the test piece from the beam, verify that **the machine does not automatically restart**, and that the initiation devices must be engaged to restart the machine.
- 7) With the guarded machine at rest, block one of the grid beams and verify that it is not possible for the guarded machine to be put into motion while the test piece is blocking a beam.
- 8) Check carefully for external signs of damage or changes to the EZ-SCREEN Grid System, the guarded machine, and their electrical wiring. Any damage or changes found should be immediately reported to management.

6.5 Semi-Annual Checkout

Perform this checkout procedure every six months following System installation. A Qualified Person (as defined in the Safety Glossary) must perform the procedure; checkout results should be recorded and kept on or near the guarded machine, per OSHA 1910.217(e)(1).

- 1) Perform the commissioning checkout procedure (Section 6.3).

If any decrease in machine braking ability has occurred, make the necessary clutch/brake repairs, readjust separation distance (Ds) appropriately, record the new Ds calculation on the Daily Checkout Procedure card and/or on page 55, and re-perform the Daily Checkout procedure.

- 2) Examine and test the machine primary control elements (MPCEs) and any intermediary controls (such as interface modules) to verify that they are functioning correctly and are not in need of maintenance or replacement.
- 3) Inspect the guarded machine to verify that no other mechanical or structural problems could prevent the machine from stopping or assuming an otherwise safe condition when signalled to do so by the EZ-SCREEN Grid System.
- 4) Examine and inspect the machine controls and connections to the EZ-SCREEN Grid System to verify that no modifications have been made which adversely affect the System.

EZ-SCREEN Grid Quick-Disconnect Models

Short-Range Models (0.8 m - 20 m)	Long-Range Models (15 m - 70 m)	Connector	Number of Beams	Beam Spacing	Protected Height
SGE2-584Q3 Emitter	SGXLE2-584Q3 Emitter	3-pin Mini-style QD, (Test input jumpered)	2	584 mm (23")	584 mm (23")
SGE2-584Q5 Emitter	SGXLE2-584Q5 Emitter	5-pin Mini-style QD, (Test input available)			
SGR2-584Q8 Receiver		8-pin Mini-style QD			
SGE3-533Q3 Emitter	SGXLE3-533Q3 Emitter	3-pin Mini-style QD, (Test input jumpered)	3	533 mm (21")	1066 mm (42")
SGE3-533Q5 Emitter	SGXLE3-533Q5 Emitter	5-pin Mini-style QD, (Test input available)			
SGR3-533Q8 Receiver		8-pin Mini-style QD			
SGE2-500Q3 Emitter	SGXLE2-500Q3 Emitter	3-pin Mini-style QD, (Test input jumpered)	2	500 mm (19.7")	500 mm (19.7")
SGE2-500Q5 Emitter	SGXLE2-500Q5 Emitter	5-pin Mini-style QD, (Test input available)			
SGR2-500Q8 Receiver		8-pin Mini-style QD			
SGE3-400Q3 Emitter	SGXLE3-400Q3 Emitter	3-pin Mini-style QD, (Test input jumpered)	3	400 mm (15.7")	800 mm (31.5")
SGE3-400Q5 Emitter	SGXLE3-400Q5 Emitter	5-pin Mini-style QD, (Test input available)			
SGR3-400Q8 Receiver		8-pin Mini-style QD			
SGE4-300Q3 Emitter	SGXLE4-300Q3 Emitter	3-pin Mini-style QD, (Test input jumpered)	4	300 mm (11.8")	900 mm (35.4")
SGE4-300Q5 Emitter	SGXLE4-300Q5 Emitter	5-pin Mini-style QD, (Test input available)			
SGR4-300Q8 Receiver		8-pin Mini-style QD			

QD Model Accessories

QD Cables

Models	Length	Wire	Termination	Banner Cable Pinout/Color Code		SAE H1738-2** Pinout/Color Code		Connector (Female Face View)	
QDS-315C QDS-325C QDS-350C QDS-3100C	5 m (15')	20 Ga	3-pin Mini-style Female connector on one end; cut-to-length.	Pin	Color	Function	Pin	Color*	Function
	1			Gn/Ye	Gnd/PE	1	Gn	Gnd/PE	
	2			Bn	+24V dc	2	Rd/Bk	+24V dc	
	3			Bl	0V dc	3	Rd/Wh	0V dc	
QDS-515C QDS-525C QDS-550C	5 m (15')	20 Ga	5-pin Mini-style Female connector on one end; cut-to-length.	Pin	Color	Function	Pin	Color*	Function
	1			Bk	Test#1	1	Wh	Test#1	
	2			Bl	0V dc	2	Rd	0V dc	
	3			Gn/Ye	Gnd/PE	3	Gn	Gnd/PE	
	4			Br	+24V dc	4	Or	+24V dc	
5	Wh	Test#2	5	Bk	Test#2				
QDS-815C QDS-825C QDS-850C	5 m (15')	20 Ga	8-pin Mini-style Female connector on one end; cut-to-length.	Pin	Color	Function	Pin	Color	Function
	1			Bn	+24V dc	1	Or	+24V dc	
	2			Or/Bk	EDM#2	2	Bu	EDM#2	
	3			Or	EDM#1	3	Wh/Bk	EDM#1	
	4			Wh	OSSD#2	4	Bk	OSSD#2	
	5			Bk	OSSD#1	5	Wh	OSSD#1	
	6			Bl	0V dc	6	Rd	0V dc	
	7			Gn/Ye	Gnd/PE	7	Gn	Gnd/PE	
8	Vi	Reset	8	Rd/Bk	Reset				

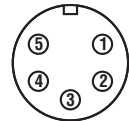
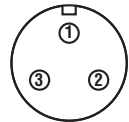

Unterminated Bulk Cable (25', 50', 100', 250')

Models	Length	Wire	Description
UTB-325C UTB-350C UTB-3100C UTB-3250C	8 m (25') 15 m (50') 30 m (100') 75 m (250')	20 Ga	3-conductor, unterminated bulk cable
UTB-525C UTB-550C UTB-5100C UTB-5250C	8 m (25') 15 m (50') 30 m (100') 75 m (250')		5-conductor, unterminated bulk cable
UTB-825C UTB-850C UTB-8100C UTB-8250C	8 m (25') 15 m (50') 30 m (100') 75 m (250')		8-conductor, unterminated bulk cable

* The 3-pin and the 5-pin connectors chosen are recommended in order to keep colors and functions as similar as possible to the Banner connectors.

** The SAE H1738-2 pin assignment and color codes are listed as a customer courtesy. The user must verify suitability of these cables for each application.

Replacement End-Caps – Converts hard-wire end cap to QD model

Models	Description
EZA-QDE-3	3-pin for emitter (Test input jumpered)
EZA-QDE-5	5-pin for emitter (Test input available)
EZA-QDE-8	8-pin for receiver

Accessory Bracket Dimensions

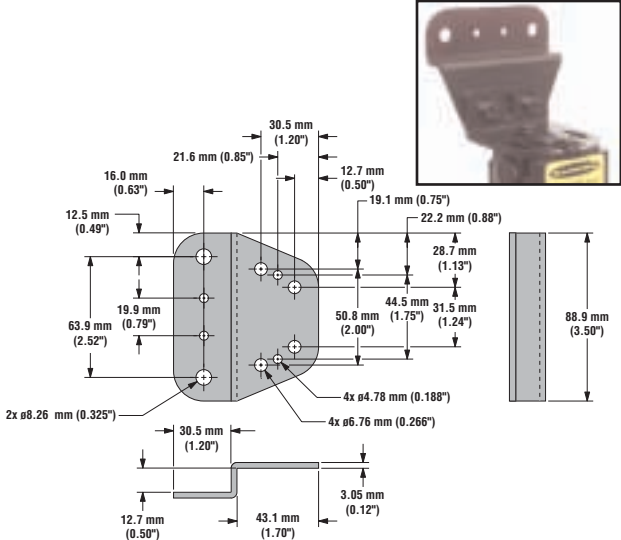
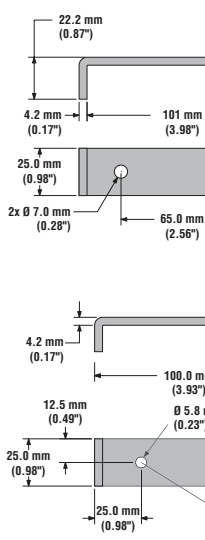
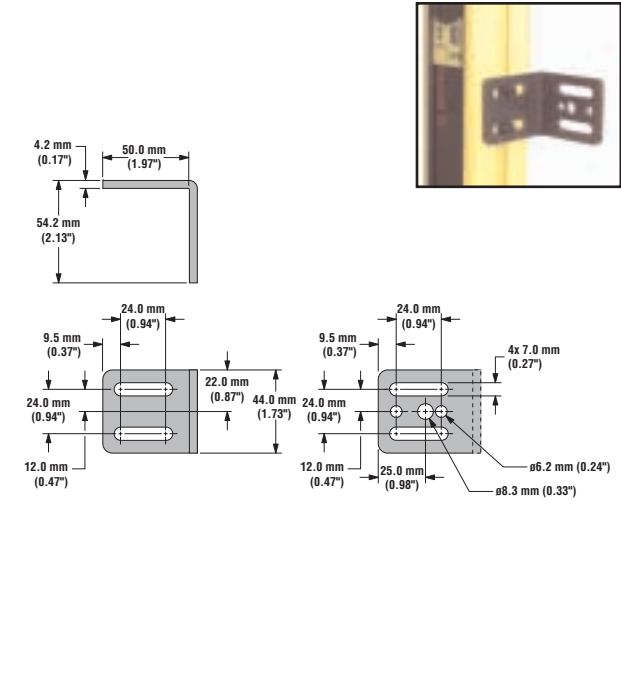
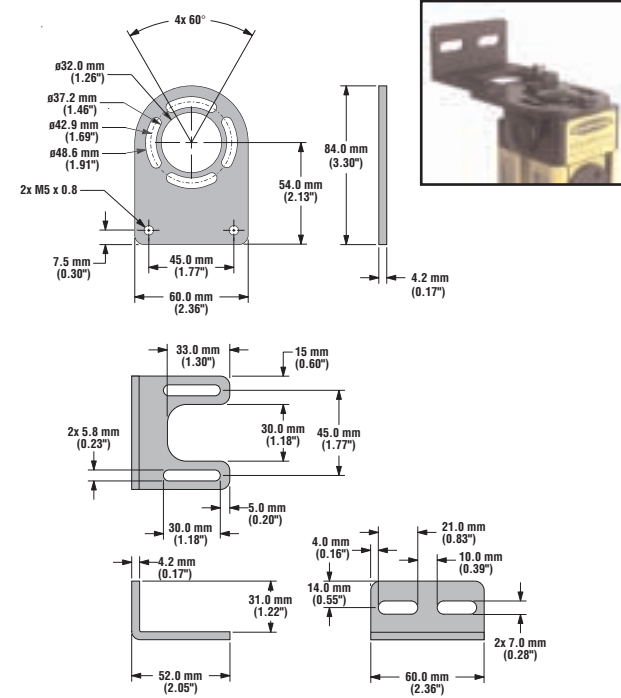
<p>EZA-MBK-2</p>	<ul style="list-style-type: none"> • Adapter Bracket Kit for MSA Series Stands • Attaches to standard EZA-MBK-1 bracket (included with sensor) • Kit includes 2 adapters 	<p>EZA-MBK-3</p>	<ul style="list-style-type: none"> • Side-Swivel Bracket Kit • Kit includes 2 adapters
 <p>Technical drawing of EZA-MBK-2 adapter bracket showing dimensions in mm and inches. Dimensions include: 12.5 mm (0.49"), 16.0 mm (0.63"), 19.9 mm (0.79"), 21.6 mm (0.85"), 22.2 mm (0.88"), 28.7 mm (1.13"), 30.5 mm (1.20"), 31.5 mm (1.24"), 35.0 mm (1.38"), 38.0 mm (1.50"), 43.1 mm (1.70"), 44.5 mm (1.75"), 45.0 mm (1.77"), 50.8 mm (2.00"), 58.0 mm (2.28"), 63.9 mm (2.52"), 65.0 mm (2.56"), 68.0 mm (2.68"), 70.0 mm (2.76"), 75.0 mm (2.95"), 88.9 mm (3.50"), 89.0 mm (3.51"), 90.0 mm (3.54"), 95.0 mm (3.74"), 100.0 mm (3.94"), 101.0 mm (3.98"), 105.0 mm (4.13"), 110.0 mm (4.33"), 115.0 mm (4.53"), 120.0 mm (4.72"), 125.0 mm (4.92"), 130.0 mm (5.12"), 135.0 mm (5.31"), 140.0 mm (5.51"), 145.0 mm (5.71"), 150.0 mm (5.91"), 155.0 mm (6.11"), 160.0 mm (6.30"), 165.0 mm (6.50"), 170.0 mm (6.70"), 175.0 mm (6.89"), 180.0 mm (7.09"), 185.0 mm (7.29"), 190.0 mm (7.48"), 195.0 mm (7.68"), 200.0 mm (7.87").</p>	 <p>Technical drawing of EZA-MBK-3 side-swivel bracket showing dimensions in mm and inches. Dimensions include: 22.2 mm (0.87"), 4.2 mm (0.17"), 101 mm (3.98"), 17 mm (0.7"), 25.0 mm (0.98"), 2x Ø 7.0 mm (0.28"), 65.0 mm (2.56"), 22.3 mm (0.87"), 100.0 mm (3.93"), 4.2 mm (0.17"), 12.5 mm (0.49"), Ø 5.8 mm (0.23"), 5.8 mm (0.23"), 13.0 mm (0.51"), 25.0 mm (0.98"), 25.0 mm (0.98"), R50.0 mm (1.97"), 13 mm (0.51"), Ø 5.8 mm (0.23").</p>		
<p>EZA-MBK-8</p>	<ul style="list-style-type: none"> • Retrofit Bracket Kit (to replace SICK/Leuze Grid systems) • Kit includes 2 brackets 	<p>EZA-MBK-9</p>	<ul style="list-style-type: none"> • Adjustable Bracket Kit • Kit includes 2 adapters
 <p>Technical drawing of EZA-MBK-8 retrofit bracket showing dimensions in mm and inches. Dimensions include: 4.2 mm (0.17"), 50.0 mm (1.97"), 54.2 mm (2.13"), 24.0 mm (0.94"), 9.5 mm (0.37"), 22.0 mm (0.87"), 44.0 mm (1.73"), 24.0 mm (0.94"), 12.0 mm (0.47"), 24.0 mm (0.94"), 9.5 mm (0.37"), 24.0 mm (0.94"), 12.0 mm (0.47"), 25.0 mm (0.98"), 4x 7.0 mm (0.27"), Ø 6.2 mm (0.24"), Ø 8.3 mm (0.33").</p>	 <p>Technical drawing of EZA-MBK-9 adjustable bracket showing dimensions in mm and inches. Dimensions include: 4x 60°, Ø 32.0 mm (1.26"), Ø 37.2 mm (1.46"), Ø 42.9 mm (1.69"), Ø 48.6 mm (1.91"), 2x M5 x 0.8, 84.0 mm (3.30"), 54.0 mm (2.13"), 7.5 mm (0.30"), 45.0 mm (1.77"), 60.0 mm (2.36"), 4.2 mm (0.17"), 33.0 mm (1.30"), 15 mm (0.60"), 2x 5.8 mm (0.23"), 30.0 mm (1.18"), 45.0 mm (1.77"), 5.0 mm (0.20"), 30.0 mm (1.18"), 4.2 mm (0.17"), 31.0 mm (1.22"), 4.0 mm (0.16"), 21.0 mm (0.83"), 10.0 mm (0.39"), 2x 7.0 mm (0.28"), 60.0 mm (2.36"), 52.0 mm (2.05").</p>		

Glossary of Safety Terms

Terms shown in *italics* in the definitions below are themselves defined elsewhere in the glossary.

ANSI (American National Standards Institute): An association of industry representatives which develops technical standards, including safety standards. These standards represent a consensus from a variety of industries on good practice and design. ANSI standards relevant to application of the EZ-SCREEN System include ANSI B11.1 (mechanical power presses), ANSI B11.2 (hydraulic power presses), and ANSI/RIA R15.06 (industrial robots and robot systems).

Blocked condition: A condition of the EZ-SCREEN Grid System when an opaque object of sufficient size blocks/interrupts one or more beams of the light grid. When a Blocked condition occurs, OSSD1 and OSSD2 outputs simultaneously turn off within the system response time.

Control reliability: A method of ensuring the performance integrity of a control system. Control circuits are designed and constructed so that a single failure or fault within the system does not prevent the normal stopping action from being applied to the machine when required, or does not create unintended machine action, but does prevent initiation of successive machine action until the failure is corrected.

Designated Person: A person or persons identified and designated in writing, by the employer, as being appropriately trained and qualified to perform a specified checkout procedure.

Diverse redundancy: A design feature in which two components of different design, running from two different instruction sets (if programmed components), constantly check all system components, including each other.

Emitter: The light-emitting component of the EZ-SCREEN Grid System, consisting of a grid of synchronized modulated infrared LEDs. The emitter, together with the *receiver*, creates a vertical “light grid” used to detect a body or torso as a person enters a hazardous area.

Final Switching Device (FSD): The component of the machine’s safety-related control system that interrupts the circuit to the machine primary control element (MPCE) when the output signal switching device (OSSD) goes to the OFF-state.

FMEA (Failure Mode and Effects Analysis): A testing procedure by which potential failure modes in a system are analyzed to determine their results or effects on the system. Component failure modes that produce either no effect or a *lockout condition* are permitted; failures which cause an unsafe condition (a *failure to danger*) are not. Banner EZ-SCREEN Systems are extensively FMEA tested.

Forced-guided contacts: Relay contacts that are mechanically linked together, so that when the relay coil is energized or de-energized, all of the linked contacts move together. If one set of contacts in the relay becomes immobilized, no other contact of the same relay will be able to move. The function of forced-guided contacts is to enable the safety circuit to check the status of the relay. Forced-guided contacts are also known as “positive-guided contacts,” “captive contacts,” “locked contacts,” or “safety relays.”

Full-revolution devices: A type of machine drive arranged such that, once started, the machine can only be stopped when the full cycle is complete. Examples include positive key clutches and similar mechanisms. Banner EZ-SCREEN Systems may not be used with full-revolution devices.

Hard guarding: Screens, bars, or other mechanical barriers that prevent a person from entering or remaining in the hazard area undetected.

Internal lockout: A *lockout condition* that occurs due to an internal EZ-SCREEN System problem. Indicated by the red Status indicator (only) flashing. Requires the attention of a *Qualified Person*.

Latch condition: The response of the OSSD outputs (they turn OFF) when an object blocks/interrupts a light beam of the EZ-SCREEN Grid system operating in Latch mode. A manual reset must be performed after all objects are removed (all beams clear) to reset the output latch and allow the outputs to turn ON.

Lockout condition: A condition of the EZ-SCREEN Grid System that is automatically attained when the System detects internal or certain external errors. A lockout condition causes all of the EZ-SCREEN Grid System OSSD outputs to turn or remain OFF, sending a stop signal to the guarded machine. To restore the EZ-SCREEN Grid System to Run mode, all errors must be corrected and a manual reset must be performed.

Machine primary control element (MPCE): An electrically powered element, external to the EZ-SCREEN System, which directly controls the machine’s normal operating motion in such a way that it is last (in time) to operate when motion is either initiated or arrested.

Machine response time: The time between the interruption by the EZ-SCREEN OSSDs and the instant when the dangerous parts of the machine reach a safe state by being brought to rest.

Machine secondary control element (MSCE): A machine control element independent of the *Machine Primary Control Element(s) (MPCEs)*, capable of removing the source of power from the prime mover of the relevant dangerous machine parts.

MPCE monitor contacts: The normally closed contacts of a guarded machine's MPCEs which are connected to the EZ-SCREEN System EDM inputs. These contacts must be mechanically linked to the control elements (*forced-guided*).

Muting: The automatic suspension of the safeguarding function of a safety device during a non-hazardous portion of the machine cycle.

OFF state: The state in which the output circuit is interrupted and does not permit the flow of current.

ON state: The state in which the output circuit is complete and permits the flow of current.

OSHA (Occupational Safety and Health Administration); OSHA CFR 1910.217: Occupational Safety and Health Administration (a US Federal agency), Division of the US Department of Labor, that is responsible for the regulation of workplace safety. OSHA regulations often follow ANSI standards, including mechanical power press requirements (OSHA CFR 1910.217). These regulations become law when adopted by OSHA, and must be followed.

Output signal switching device (OSSD): The component of the electro-sensitive protective equipment (ESPE) connected to the control system of the machine which, when the sensing device is actuated during normal operation, responds by going to the OFF-state.

Point of operation: The area of the *guarded machine* where a workpiece is positioned and a machine function (e.g., shearing, forming, punching, assembling, welding) is performed upon it.

Protected height: The distance between the center of the top beam and the center of the bottom beam of a light grid.

PSDI (Presence-Sensing-Device Initiation): An application in which a presence-sensing device is used to actually start the cycle of a machine. In a typical situation, an operator manually positions a part in the machine for the operation. When the operator moves out of the hazardous area, the presence-sensing device starts the machine (no start switch is used). The machine cycle runs to completion, and the operator can then insert a new part and start another cycle. The presence-sensing device continually guards the machine. Single break mode is used when the part is automatically ejected after the machine operation. Double break mode is used when the part is both inserted (to begin

the operation) and removed (after the operation) by the operator. PSDI is defined in OSHA CFR 1910.217. *Banner EZ-SCREEN Systems may not be used as PSDI devices on mechanical power presses, per OSHA regulation 29 CFR 1910.217.*

Qualified Person: A person or persons who, by possession of a recognized degree or certificate of professional training, or who, by extensive knowledge, training, and experience, has successfully demonstrated the ability to solve problems relating to the subject matter and work.

Receiver: The light-receiving component of the EZ-SCREEN Grid System, consisting of a grid of synchronized phototransistors. The receiver, together with the emitter, creates a vertical light grid used to detect a body or torso as a person enters a hazardous area.

Reset: The use of a manually operated switch to restore the OSSDs to the ON state from a *lockout or a latch condition*.

Self-checking (circuitry): A circuit with the capability to electronically verify that all of its own critical circuit components, along with their redundant backups, are operating properly. Banner EZ-SCREEN Systems are self-checking.

Separation distance: That distance, along the direction of approach, between the outermost position at which the appropriate test piece will just be detected and the nearest dangerous machine parts. Also called safety distance.

Single-stroke press: See *full-revolution devices*.

Supplemental guarding: Additional electrosensitive safety device(s), and/or hard guarding measures, used for the purpose of preventing a person from entering or remaining in the hazard area undetected.

Test piece: An opaque object of sufficient size used to block a light grid beam to test the operation of the EZ-SCREEN Grid System.

UL (Underwriters Laboratory): A third-party organization which tests a manufacturer's products for compliance with appropriate Standards, electrical and/or safety codes. Compliance is indicated by their listing mark on the product.

U.S. Application Standards

ANSI B11.1

Machine Tools – Mechanical Power Presses – Safety Requirements for Construction, Care, and Use of

ANSI B11.2

Hydraulic Power Presses – Safety Requirements for Construction, Care, and Use of

ANSI B11.3

Power Press Brakes – Safety Requirements for Construction, Care, and Use of

ANSI B11.4

Shears – Safety Requirements for Construction, Care, and Use of

ANSI B11.5

Machine Tools – Iron Workers – Safety Requirements for Construction, Care, and Use of

ANSI B11.6

Lathes – Safety Requirements for Construction, Care, and Use of

ANSI B11.7

Cold Headers and Cold Formers – Safety Requirements for Construction, Care, and Use of

ANSI B11.8

Drilling, Milling, and Boring Machines – Safety Requirements for Construction, Care, and Use of

ANSI B11.9

Grinding Machines – Safety Requirements for Construction, Care, and Use of

ANSI B11.10

Metal Sawing Machines – Safety Requirements for Construction, Care, and Use of

ANSI B11.11

Gear Cutting Machines – Safety Requirements for Construction, Care, and Use of

ANSI B11.12

Roll Forming and Roll Bending Machines – Safety Requirements for Construction, Care, and Use of

ANSI B11.13

Machine Tools – Single – and Multiple-Spindle Automatic Bar and Chucking Machines – Safety Requirements for Construction, Care, and Use of

ANSI B11.14

Coil Slitting Machines/Systems – Safety Requirements for Construction, Care, and Use of

ANSI B11.15

Pipe, Tube, and Shape Bending Machines – Safety Requirements for Construction, Care, and Use of

ANSI B11.16

Metal Powder Compacting Presses – Safety Requirements for Construction, Care, and Use of

ANSI B11.17

Horizontal Extrusion Presses – Safety Requirements for Construction, Care, and Use of

ANSI B11.18

Machinery and Machine Systems for the Processing of Coiled Strip, Sheet, and Plate – Safety Requirements for Construction, Care, and Use of

ANSI B11.19

Performance Criteria for the Design, Construction, Care, and Operation of Safeguarding when Referenced by the Other B11 Machine Tool Safety Standards

ANSI B11.20

Machine Tools – Manufacturing Systems/Cells – Safety Requirements for Construction, Care, and Use of

ANSI/RIA R15.06 (1999)

Safety Requirements for Industrial Robots and Robot Systems

NFPA 79

Electrical Standard for Industrial Machinery 1994 Edition

SOURCES

ANSI B11 Documents

American National Standards Institute

11 West 42nd Street
New York, NY 10036
Telephone: (212) 642-4900

-or-

Safety Director

AMT – The Association for Manufacturing Technology

7901 Westpark Drive
McLean, VA 22102-4269
Telephone: (703) 893-2900

ANSI/RIA Documents

Obtain from ANSI (above) or:

Robotics Industries Association

900 Victors Way, P.O. Box 3724

Ann Arbor, MI 48106

Telephone: (734) 994-6088

NFPA Documents

National Fire Protection Association

1 Batterymarch Park

P.O. Box 9101

Quincy, MA 02269-9101

Telephone: (800) 344-3555

SOURCE

Underwriters Laboratories Inc.
333 Pfingsten Road
Northbrook, IL 60062-2096
Telephone: (847) 272-8800

SOURCE

Part of:
Code of Federal Regulations
Title 29, Parts 1900 to 1910
Superintendent of Documents
Government Printing Office
P.O. Box 371954
Pittsburgh, PA 15250-7954
Telephone: (202) 512-1800

SOURCES***IEC, ISO and EN Standards***

Available from:

Global Engineering Documents
15 Inverness Way East
Englewood, CO 80112-5704
Phone: 1 (800) 854-7179
Fax: (303) 397-2740

BS Documents

British Standards Association
2 Park Street
London W1A 2BS
England
Telephone: 011-44-908-1166

U.S. Design Standards**UL 991**

Tests for Safety-Related Controls
Employing Solid-state Devices

UL 1998

Standard for Safety-Related Software

OSHA Regulations**OSHA 29 CFR 1910.212**

General Requirements for (Guarding
of) All Machines

OSHA 29 CFR 1910.217

(Guarding of) Mechanical Power
Presses

OSHA 29 CFR 1910.147

The Control of Hazardous Energy
(Lockout/Tagout)

International and European Standards**ISO 10218, EN 775 (DIN)**

Manipulating Industrial Robots –
Safety

ISO/TR 12100-1, EN 292-1

Safety of Machinery – Basic
Concepts, General Principles for
Design Part 1: Basic Terminology,
Methodology

ISO/TR 12100-2, EN 292-2

Safety of Machinery – Basic
Concepts, General Principles for
Design Part 2: Technical Principals
and Specifications

ISO 13849, EN 954-1

Safety of Machinery – Safety Related
Parts of Control Systems

ISO 13850, EN 418

Safety of Machinery – Emergency
Stop Devices, Functional Aspects –
Principles for Design

ISO/DIS 13851, EN 574

Safety of Machinery – Two-hand
control devices – Functional Aspects
– Principles for Design

ISO 13852, EN 294

Safety of Machinery – Safety
Distances to Prevent Danger Zones
Being Reached by the Upper Limbs

ISO 13853, EN 811

Safety of Machinery – Safety
Distances to Prevent Danger Zones
Being Reached by the Lower Limbs

ISO/DIS 13855, EN 999

Safety of Machinery – The Positioning
of Protective Equipment in Respect to
Approach Speeds of Parts of the
Human Body

ISO 14119, EN 1088

Safety of Machinery – Interlocking
Devices Associated with Guards –
Principles for Design and Selection

ISO 14121, EN 1050

Safety of Machinery – Principles of
Risk Assessment

IEC/EN 60204-1

Electrical Equipment of Machines
Part 1: General Requirements

IEC 60529

Degrees of Protection Provided by
Enclosures

IEC/EN 60947-1

Low Voltage Switchgear –
General Rules

IEC/EN 60947-5-1

Low Voltage Switchgear –
Electromechanical Control Circuit
Devices

IEC/EN 61496

Safety of Machinery – Electro-
sensitive Protection Equipment



WARRANTY: Banner Engineering Corp. warrants its products to be free from defects for one year. Banner Engineering Corp. will repair or replace, free of charge, any product of its manufacture found to be defective at the time it is returned to the factory during the warranty period. This warranty does not cover damage or liability for the improper application of Banner products. This warranty is in lieu of any other warranty either expressed or implied.