



MotionView®
OnBoard

PositionServo with MVOB
Users Manual
Valid for Hardware Version 2

Copyright ©2010 by Lenze AC Tech Corporation.

All rights reserved. No part of this manual may be reproduced or transmitted in any form without written permission from Lenze AC Tech Corporation. The information and technical data in this manual are subject to change without notice. Lenze AC Tech makes no warranty of any kind with respect to this material, including, but not limited to, the implied warranties of its merchantability and fitness for a given purpose. Lenze AC Tech assumes no responsibility for any errors that may appear in this manual and makes no commitment to update or to keep current the information in this manual.

MotionView®, PositionServo®, and all related indicia are either registered trademarks or trademarks of Lenze AG in the United States and other countries.

Windows™ and all related indicia are registered trademarks of Microsoft Corporation.

Java™ and all related indicia are registered trademarks of Sun Microsystems, Incorporated.

CANopen® is a registered trademark of 'CAN in Automation (CiA)'.

DeviceNet™, EtherNet/IP™, and all related indicia are trademarks of ODVA (Open Device Vendors Association).

PROFIBUS DP™ is a registered trademark of PROFIBUS International.

This document printed in the United States of America.



1	Introduction	5
1.1	Safety Information	5
1.2	Legal Regulations	5
1.3	General Drive Information	6
1.3.1	Mains Configuration	6
1.3.2	Operating Modes	7
1.3.3	Feedback	7
1.3.4	Software	7
1.4	Part Number Designation	8
1.4.1	Drive Part Number	8
1.4.2	Filter Part Number	8
1.4.3	Option Part Number	9
2	Technical Data	10
2.1	Electrical Characteristics	10
2.2	Power Ratings	11
2.3	Fuse Recommendations	12
2.4	Digital and Analog I/O Ratings	12
2.5	Environment	13
2.6	Operating Modes	13
2.7	Connections and I/O	13
2.8	PositionServo Dimensions	14
2.9	Clearance for Cooling Air Circulation	15
3	Installation	16
3.1	Wiring	17
3.2	Shielding and Grounding	17
3.2.1	General Guidelines	17
3.2.2	EMI Protection	18
3.2.3	Enclosure	18
3.3	Line Filtering	18
3.4	Heat Sinking	19
3.5	Line (Mains) Fusing	19
4	Interface	20
4.1	External Connectors	20
4.1.1	P1 & P7 - Input Power and Output Power Connections	20
4.1.2	P2 - Ethernet Communications Port	21
4.1.3	P3 - Controller I/O	22
4.1.4	P4 - Motor Feedback	23
4.1.5	P5 - 24 VDC Back-up Power Input	24
4.1.6	P6 - Braking Resistor and DC Bus	25
4.1.7	Connector and Wiring Notes	25
4.1.8	P8 - ISO 13849-1 Safety Circuit (option)	26
4.2	Digital I/O Details	32
4.2.1	Step & Direction / Master Encoder Inputs (P3, pins 1-4)	32
4.2.2	Buffered Encoder Output (P3, pins 7-12)	33
4.2.3	Digital Outputs	33
4.2.4	Digital Inputs	34
4.3	Analog I/O Details	35
4.3.1	Analog Reference Input	35
4.3.2	Analog Output	36
4.4	Communication Interfaces	36
4.4.1	Ethernet Interface (standard)	36
4.4.2	RS485 Interface (option)	36
4.4.3	Modbus RTU Support	37
4.4.4	CANopen Interface	37
4.4.5	DeviceNet Interface	37
4.4.6	PROFIBUS DP Interface	38
4.5	Motor Selection	38
4.5.1	Motor Connection	38
4.5.2	Motor Over-Temperature Protection	38



Contents

5	Parameters	39
5.1	Drive Identification	40
5.1.1	Drive Name	40
5.1.2	Group ID	40
5.2	Motor	41
5.2.1	Motor Setup	41
5.2.2	Using a Custom Motor	42
5.2.3	Creating Custom Motor Parameters	42
5.2.4	Autophasing	43
5.2.5	Custom Motor Data Entry	44
5.3	Parameters	48
5.3.1	Drive Mode	49
5.3.2	Reference	50
5.3.3	Drive PWM Frequency	50
5.3.4	Current Limit	50
5.3.5	To Change Current Limits	50
5.3.6	Peak Current Limit (8 kHz and 16 kHz)	50
5.3.7	Accel/Decel Limits (velocity mode only)	51
5.3.8	Fault Reset	51
5.3.9	Motor Temperature Sensor	51
5.3.10	Motor PTC Cutoff Resistance	51
5.3.11	Regen Duty Cycle	51
5.3.12	Master Encoder Input Type (position mode only)	52
5.3.13	Master Encoder - System to Master Ratio	52
5.3.14	Autoboot	52
5.3.15	User Units	52
5.3.16	Rotation Direction	53
5.3.17	Resolver Tracks	53
5.4	Communication	54
5.4.1	Ethernet	54
5.4.2	RS-485	54
5.4.3	CAN	54
5.4.4	PROFIBUS	54
5.5	Analog I/O	55
5.5.1	Analog Output	55
5.5.2	Analog Output Current Scale (Volt/Amps)	55
5.5.3	Analog Output Velocity Scale (mV/RPM)	55
5.5.4	Analog Input Current Scale (Amps/Volt)	55
5.5.5	Analog Input Velocity Scale (RPM/Volt)	55
5.5.6	Analog Input Dead Band	56
5.5.7	Analog Input Offset	56
5.6	Digital I/O	56
5.6.1	Digital Output	56
5.6.2	Digital Input De-bounce Time	56
5.6.3	Hard Limit Switch Action	56
5.6.4	Enable Switch Function	56
5.6.5	Brake Release Delay	57
5.7	Velocity Limits	57
5.7.1	Zero Speed	57
5.7.2	Speed Window	57
5.7.3	At Speed	57
5.8	Position Limits	58
5.8.1	Position Error	58
5.8.2	Max Error Time	58
5.8.3	Soft Limits	58



5.9	Compensation	58
5.9.1	Velocity P-gain (proportional)	58
5.9.2	Velocity I-gain (integral)	58
5.9.3	Position P-gain (proportional)	59
5.9.4	Position I-gain (integral)	59
5.9.5	Position D-gain (differential)	59
5.9.6	Position I-limit	59
5.9.7	Gain Scaling Window	59
5.9.8	Disable High Performance Mode	59
5.9.9	Auto Tuning	59
5.9.10	Set Default Gains	60
5.9.11	Feedback and Loop Filters	60
5.10	Tools	61
5.10.1	Oscilloscope	61
5.10.2	Parameter & I/O View	62
5.11	Faults	63
5.12	Monitor	64
6	Operation	65
6.1	Minimum Connections	65
6.2	Ethernet Connection	65
6.2.1	PositionServo Ethernet Port Configuration	66
6.2.2	Configuring the PC IP Address (Windows XP)	68
6.2.3	Initial Connection to the Drive	71
6.2.4	Launching MotionView & Communicating to the PS Drive	72
6.3	Parameter Storage and EPM Operation	75
6.3.1	Parameter Storage	75
6.3.2	EPM Operation	75
6.3.3	EPM Fault	75
6.4	Configuration of the PositionServo	76
6.5	Position Mode Operation (gearing)	77
6.6	Enabling the PositionServo	77
6.7	Drive Tuning	78
6.7.1	Auto Tuning the Drive	78
6.7.2	Manually Tuning the Drive in Velocity Mode	79
6.7.3	Manually Tuning the Drive in Position Mode	84
6.8	Upgrading Firmware	90
7	Quick Start Reference	91
7.1	Quick Start - External Torque Mode	91
7.2	Quick Start - External Velocity Mode	92
7.3	Quick Start - External Positioning Mode	94
8	Diagnostics	96
8.1	Diagnostic Display	96
8.2	Diagnostic LEDs	97
8.3	Stop/Reset	97
8.4	Faults	98
8.4.1	Fault Codes	98
8.4.2	Fault Event	99
8.4.3	Fault Reset	100
8.4	Troubleshooting	100

About These Instructions



This documentation pertains to the PositionServo drive with Hardware Version 2. This documentation contains important technical data regarding the installation, operation and commissioning of the drive. Observe all safety instructions. Read this document in its entirety before operating or servicing a PositionServo drive.

Drive Hardware Version

For hardware version 2, the drive dataplate (identification label) displays "2" in the fourth to last digit of the drive identification number. Refer to "E" designation in the drive identification label. Upon power-up the drive LED display will read "9402" to indicate 940 PositionServo, hardware version 2.

If upon power-up the drive LED reads "940", the drive has hardware version 1. Refer to User Manual S94PM01 for hardware version 1 drives.

Drive Identification Label

A	B	C	D	E	F
 Made in USA POSITIONServo Model 940	Type: E94P120Y2NES ID-No: 13014745	INPUT: 1(3)/PE 120/240 V 24.0 (13.9) A 50-60 HZ	OUTPUT: 3/PE 0 - 230 V 12.0 A	For detailed information refer to instruction Manual: S94H201 SN 13014745012345678 E94P120Y2NES0XX2###	
	LISTED  5D81 US IND. CONT. EQ.				

A	B	C	D	E	F
Certifications	Model Number	Input Ratings	Output Ratings	Hardware Version	Software Version

Package Contents

Scope of Supply	Important
1 Model PositionServo: Type E94P or E94R 1 Users Manual (English) 1 MotionView CD ROM including: - configuration software - documentation	After reception of the delivery, immediately check whether the scope of supply matches the accompanying papers. Lenze- AC Tech does not accept any liability for deficiencies claimed subsequently. Claim: - visible transport damage immediately to the forwarder - visible deficiencies / incompleteness immediately to your Lenze representative.

Related Documents

The documentation listed herein contains information relevant to the operation of the PositionServo and MotionView OnBoard. To obtain the latest documentation, visit the Technical Library at <http://www.lenzeamericas.com>.

Table 1: Reference Documentation

Document #	Description
PM94H201	PositionServo (with MVOB) Programming Manual
P94MOD01	Position Servo ModBus RTU over RS485 ; Modbus TCP/IP
P94CAN01	PositionServo CANopen Communications Reference Guide
P94DVN01	PositionServo DeviceNet Communications Reference Guide
P94ETH01	PositionServo EtherNet/IP Communications Reference Guide
P94PFB01	PositionServo PROFIBUS Communications Reference Guide



1 Introduction

1.1 Safety Information

The safety information provided in this documentation has the layout shown herein.



Signal Word! (Characteristics the severity of the danger)
Note (describes the danger and informs on how to proceed)

Table 2: Pictographs used in these Instructions

Icon		Signal Words	
	Warning of hazardous electrical voltage	DANGER!	Warns of impending danger . Consequences if disregarded: Death or severe injuries.
	Warning of a general danger	WARNING!	Warns of potential, very hazardous situations . Consequences if disregarded: Death or severe injuries.
	Warning of damage to equipment	STOP!	Warns of potential damage to material and equipment . Consequences if disregarded: Damage to the controller/drive or its environment.
	Information	NOTE	Designates a general, useful note. If you observe it, handling the controller/drive system is made easier.

1.2 Legal Regulations

Table 2 lists the identification, application, liability, warranty and disposal information for the PositionServo drive.

Table 3: Legal Disclaimers

Claim	Description		
Identification	Nameplate	CE Identification	Manufacturer
	Lenze controllers are unambiguously designated by the contents of the nameplate	In compliance with the EC Low-Voltage Directive	Lenze AC Tech Corporation 630 Douglas Street Uxbridge, MA 01569 USA
Application as directed	<p>E94P or E94R servo controller</p> <ul style="list-style-type: none"> • must only be operated under the conditions prescribed in these Instructions. • are components for: <ul style="list-style-type: none"> - Closed loop control of Velocity, Torque, or Positioning applications with AC synchronous servo or induction motors. - installation in a machine. - assembly with other components to form a machine. • are electric units for installation in control cabinets or similarly enclosed housing. • comply with the requirements of the Low-Voltage Directive. • are not machines for the purpose of the Machinery Directive. • are not to be used as domestic appliances, but only for industrial purposes. 		
Application as directed	<p>Drive systems with E94P or E94R servo inverters</p> <ul style="list-style-type: none"> • comply with the EMC Directive if they are installed according to the guidelines of CE-typical drive systems. • can be used for: <ul style="list-style-type: none"> - for operation on public and non-public mains - for operation in industrial premises and residential areas. • The user is responsible for the compliance of his application with the EC directives. <p>Any other use shall be deemed as inappropriate!</p>		

Note: Table 3 continued on next page.



Introduction

Claim	Description		
Liability	<ul style="list-style-type: none"> The information, data, and notes in these instructions met the latest design and implementation of the drive at the time of publication. Claims on modifications referring to controllers that have already been supplied cannot be derived from the information, illustrations, and descriptions. The specifications, processes and circuitry described in these instructions are for guidance only and must be adapted to your own specific application. Lenze does not take responsibility for the suitability of the process and circuit proposals. The specifications in these Instructions describe the product features without guaranteeing them. Lenze does not accept any liability for damage and operating interference caused by: <ul style="list-style-type: none"> - Disregarding the operating instructions - Unauthorized modifications to the controller - Operating errors - Improper working on and with the controller 		
Warranty	<ul style="list-style-type: none"> Warranty conditions: refer to Lenze AC Tech Terms and Conditions of Sale, document TD03. 		
Disposal	Material	Recycle	Dispose
	Metal	•	-
	Plastic	•	-
	Assembled PCB's	-	•

1.3 General Drive Information

1.3.1 Mains Configuration

The PositionServo is available in four mains (input power) configurations:

1. 120/240V Single Phase (Voltage Doubler) Units

When wired for **Doubler mode** (L1-N), the input is for 120V nominal only and can range from 45VAC to 132 VAC and the maximum output voltage is double the input voltage. When wired to terminals L1-L2/N, the input can range from 80 VAC to 264 VAC and the maximum output voltage is equal to the input voltage.

2. 120/240V Single Phase (Filtered) Units

120/240V (nominal) single phase input with integrated input mains (line) filter. Actual input voltage range: 80VAC to 264VAC. The maximum output voltage is approximately equal to the input voltage.

3. 120/240V Single or Three Phase Units

120V or 240V (nominal) single or three phase input. Actual input voltage range: 80VAC to 264VAC. The maximum output voltage is approximately equal to the input voltage. An external input mains (line) filter is available.

4. 400/480V Three phase Units

400/480V (nominal) three phase input. An external input mains (line) filter is available. Actual voltage range: 320 - 528 VAC.



1.3.2 Operating Modes

The PositionServo drive can operate in one of three mode settings, torque (current), velocity, or positioning. The drive's command or reference signal can come from one of three sources. The first is an external reference. An external reference can be an analog input signal, a step and direction input or an input from a master encoder. The second reference is an internal reference. An internal reference is when the commanded reference is derived from the drive's user program. The third reference is when the commanded reference is given by a host device over a communications network. This Host device can be an external motion controller, PLC, HMI or PC. The communication network can be over, RS485 (Point-to-Point or Modbus RTU), Ethernet (using MotionView DLL's), Modbus over TCP/IP, CANopen (DS301), EtherNet/IP, DeviceNet or PROFIBUS DP.

1.3.3 Feedback

Depending on the primary feedback, there are two types of drives: the Model 940 PositionServo encoder-based drive which accepts an incremental encoder with Hall channel inputs and the Model 941 PositionServo resolver-based drive which accepts resolver inputs. The feedback signal is brought back to the P4 connector on the drive. This connector will be a 15 pin D-sub for the encoder version and a 9 pin D-sub for the resolver version.

1.3.4 Software

MotionView software is the setup and management tool for the PositionServo drive. All parameters can be set and monitored via this software tool. It has a real-time oscilloscope tool for analysis and optimum tuning. The users program, written with SimpleMotion Programming Language (SML), can be utilized to command motion and handle the drive's analog and digital I/O (inputs and outputs). The programming language is a Basic-like language designed to be very intuitive and easy to implement. For programming details, refer to the PositionServo Programming Manual. All PositionServo related manuals can be downloaded from the Technical Library on the Lenze AC Tech website (<http://www.lenzeamericas.com>).

On each PositionServo drive, there is an Electronic Programming Module (EPM), which stores all drive setup and tuning gain settings. This module can be removed from the drive and reinstalled into another drive, making the field replacement of the drive extremely easy. This also makes it easy to duplicate the settings for several drives.

The PositionServo drive supports a variety of communication protocols, including Point-to-Point (PPP), Modbus RTU over RS485, Ethernet TCP/IP, Modbus over TCP/IP, CANopen (DS301), EtherNet/IP, DeviceNet and PROFIBUS DP.



Introduction

1.4 Part Number Designation

The table herein describes the part number designation for the PositionServo drive. The available filter and communication options are detailed in separate tables.

1.4.1 Drive Part Number

	E94	P	020	S	1	N	E	M
Electrical Products in the 94x Series								
P = PositionServo Model 940 with Encoder Feedback								
R = PositionServo Model 941 with Resolver Feedback								
Drive Rating in Amps:								
020 = 2 Amps			090 = 9 Amps					
040 = 4 Amps			100 = 10 Amps					
050 = 5 Amps			120 = 12 Amps					
060 = 6 Amps			180 = 18 Amps					
080 = 8 Amps								
Input Phase:								
S = Single Phase Input only								
Y = Single or Three Phase Input								
T = Three Phase Input only								
Input Voltage:								
1 = 120 VAC Doubler (120V, 1~ in/ 240V, 3~ out)								
2 = 200/240 VAC								
4 = 400/480 VAC								
Line Filter:								
N = No Line Filter*								
F = Integrated Line Filter								
Secondary Feedback:								
E = Incremental Encoder								
R = Standard Resolver								
Safety Option:								
M = MotionView OnBoard, no ISO 13849-1 safety compliance								
S = MotionView OnBoard, with ISO 13849-1 safety compliance								

* For 3-phase EMC installation, model 940 EMC footprint/side mount filters are required.

1.4.2 Filter Part Number

	E94Z	F	4	T	4	A1
Electrical Option in the 94x Series						
F = EMC Filter						
Filter Current Rating in Amps:						
04 = 4.4 Amps		12 = 12 Amps				
07 = 6.9 Amps		15 = 15 Amps				
10 = 10 Amps		24 = 24 Amps				
Input Phase:						
S = Single Phase						
T = Three Phase						
Max Voltage:						
2 = 240 VAC						
4 = 400/480 VAC						
Degree of Filtering/Variation						
A1 = Industrial/1st Variation						
A2 = Industrial/2nd Variation						



1.4.3 Option Part Number

	E94Z	A	CAN	1
Electrical Option in the 94x Series				
A = Communication or Breakout Module				
Module Type:				
Communication:		Breakout:		
CAN = CANopen COMM Module		HBK = Motor Brake Terminal Module		
RS4 = RS485 COMM Module		TBO = Terminal Block I/O Module		
DVN = DeviceNet COMM Module		SCA = Panel Saver I/O Module		
PFB = PROFIBUS COMM Module				
Variations				
1 = 1st Variation				
2 = 2nd Variation				
3 = 3rd Variation				



2 Technical Data

2.1 Electrical Characteristics

Single-Phase Models					
Type ⁽¹⁾	Mains Voltage ⁽²⁾	1~ Mains Current (doubler)	1~ Mains Current (Std.)	Rated Output Current ⁽⁵⁾	Peak Output Current ⁽⁶⁾
E94_020S1N_~	120V ⁽³⁾ or 240V ⁽⁴⁾	9.7	5.0	2.0	6
E94_040S1N_~		15	8.6	4.0	12
E94_020S2F_~	120 / 240V ⁽⁴⁾ (80 V -0%...264 V +0%)	--	5.0	2.0	6
E94_040S2F_~		--	8.6	4.0	12
E94_080S2F_~		--	15.0	8.0	24
E94_100S2F_~		--	18.8	10.0	30
Single/Three-Phase Models					
Type ⁽¹⁾	Mains Voltage ⁽²⁾	1~ Mains Current	3~ Mains Current	Rated Output Current ⁽⁵⁾	Peak Output Current ⁽⁶⁾
E94_020Y2N_~	120 / 240V ⁽⁴⁾ 1~ or 3~ (80 V -0%...264 V +0%)	5.0	3.0	2.0	6
E94_040Y2N_~		8.6	5.0	4.0	12
E94_080Y2N_~		15.0	8.7	8.0	24
E94_100Y2N_~		18.8	10.9	10.0	30
E94_120Y2N_~		24.0	13.9	12.0	36
E94_180T2N_~	240V 3~ (180 V -0%...264 V +0%)	--	19.6	18.0	54
E94_020T4N_~	400 / 480V 3~ (320 V -0%...528 V +0%)	--	2.7	2.0	6
E94_040T4N_~		--	5.5	4.0	12
E94_050T4N_~		--	6.9	5.0	15
E94_060T4N_~		--	7.9	6.0	18
E94_090T4N_~		--	12.0	9.0	27

- (1) The first "_" equals "P" for the 940 encoder based drive or "R" for the 941 resolver based drive.
The second "_" equals "E" for incremental encoder (must have E94P drive) or "R" for the standard resolver (must have E94R drive).
The last digit "-" equals "M" for MV OnBoard and no ISO 13849-1 circuit or "S" for MV OnBoard plus the ISO 13849-1 circuit.
- (2) Mains voltage for operation on 50/60 Hz AC supplies (48 Hz -0% ... 62Hz +0%).
- (3) Connection of 120VAC (45 V ... 132 V) to input power terminals L1 and N on these models doubles the voltage on motor output terminals U-V-W for use with 230VAC motors.
- (4) Connection of 240VAC or 120VAC to input power terminals L1 and L2 on these models delivers an equal voltage as maximum to motor output terminals U-V-W allowing operation with either 120VAC or 230VAC motors.
- (5) Drive rated at 8kHz Carrier Frequency. Derate Continuous current by 17% at 16kHz.
- (6) Peak RMS current allowed for up to 2 seconds. Peak current rated at 8kHz. Derate by 17% at 16kHz.
- (7) Derate rated output current and peak output current by 2.5% for every °C above 40°C up to 55°C maximum.



Electrical Specifications applicable to all models:

Acceleration Time Range (Zero to Max Speed)	0.1 ... 5x10 ⁶ RPM/sec
Deceleration Time Range (Max Speed to Zero)	0.1 ... 5x10 ⁶ RPM/sec
Speed Regulation (typical)	± 1 RPM
Input Impedance (AIN+ to COM and AIN+ to AIN-)	47 kΩ
Power Device Carrier Frequency (sinusoidal commutation)	8, 16 kHz
Power Supply (max)	+5 VDC @ 300 mA
Maximum Encoder Feedback Frequency	2.1 MHz (per channel)
Maximum Output Frequency (to motor)	400 Hz
Resolver Carrier Frequency	4.5 - 5.5kHz (5kHz nom)
Resolver Turns Ratio: Reference to SIN/COS signal	2:1

2.2 Power Ratings

Type ⁽¹⁾	Output Power at Rated Output Current (8kHz) ⁽²⁾	Leakage Current	Power Loss at Rated Output Current (8kHz)	Power Loss at Rated Output Current (16 kHz) ⁽³⁾
Units	kVA	mA	Watts	Watts
E94_020S1N_~	0.8	Typically >3.5 mA. Consult factory for applications requiring <3.5 mA.	19	21
E94_040S1N_~	1.7		29	30
E94_020S2F_~	0.8		19	21
E94_040S2F_~	1.7		29	30
E94_080S2F_~	3.3		61	63
E94_100S2F_~	4.2		80	85
E94_020Y2N_~	0.8		19	21
E94_040Y2N_~	1.7		29	30
E94_080Y2N_~	3.3		61	63
E94_120Y2N_~	5.0		114	129
E94_180T2N_~	7.5		171	195
E94_020T4N_~	1.7		31	41
E94_040T4N_~	3.3		50	73
E94_050T4N_~	4.2		70	90
E94_060T4N_~	5.0		93	122
E94_090T4N_~	7.5		138	182

- (1) The first "_" equals "P" for the Model 940 encoder based drive or "R" for the Model 941 resolver based drive. The second "_" equals "E" for incremental encoder (must have E94P drive) or "R" for the standard resolver (must have E94R drive).
The last digit "-" equals "M" for MV OnBoard and no ISO 13849-1 circuit or "S" for MV OnBoard plus the ISO 13849-1 circuit.
- (2) At 240 VAC line input for drives with suffixes "S1N", "S2F", "Y2N". At 480 VAC line input for drives with suffixes "T4N".
a. The output power is calculated from the formula: output kVA = $[(\sqrt{3}) \times U_{line} \times I_{rated}] / 1000$
b. The actual output power (kW) depends on the motor in use due to variations in motor rated voltage, rated speed and power factor, as well as actual max operating speed and desired overload capacity.
c. Typical max continuous power (kW) for PM servo motors run 50-70% of the kVA ratings listed.
- (3) At 16 kHz, de-rate continuous current by 17%



Technical Data

2.3 Fuse Recommendations

Type ⁽¹⁾	AC Line Input Fuse (1ø/3ø)	Miniature Circuit Breaker ⁽⁴⁾ (1ø/3ø)	AC Line Input Fuse or Breaker ^{(5) (6)} (N. America)	DC Bus Input Fuse ⁽⁷⁾
Amp Ratings				
E94_020S1N_~	M20/M10	C20/C10	20/10	10
E94_040S1N_~	M32/M20	C32/C20	30/20	20
E94_020S2F_~	M20	C20	20	15
E94_040S2F_~	M20	C20	20	20
E94_080S2F_~	M32	C32	32	40
E94_100S2F_~	M40	C40	40	45
E94_020Y2N_~	M20/M16	C20/C16	20/15	15
E94_040Y2N_~	M20/M16	C20/C16	20/15	20
E94_080Y2N_~	M32/M20	C32/C20	30/20	40
E94_120Y2N_~	M50/M32	C50/C32	50/30	55
E94_180T2N_~	M40	C40	40	80
E94_020T4N_~	M10	C10	10	10
E94_040T4N_~	M10	C10	10	20
E94_050T4N_~	M16	C16	15	25
E94_060T4N_~	M20	C20	20	30
E94_090T4N_~	M25	C25	25	40

- (1) The first "_" equals "P" for the Model 940 encoder based drive or "R" for the Model 941 resolver based drive.
The second "_" equals "E" for incremental encoder (must have E94P drive) or "R" for the standard resolver (must have E94R drive).
The last digit "--" equals M" for MV OnBoard and no ISO 13849-1 circuit or "S" for MV OnBoard plus the ISO 13849-1 circuit.
- (4) Installations with high fault current due to large supply mains may require a type D circuit breaker.
- (5) UL Class CC or T fast-acting current-limiting type fuses, 200,000 AIC, preferred. Bussman KTK-R, JJJ, JJS or equivalent.
- (6) Thermal-magnetic type breakers preferred.
- (7) DC-rated fuses, rated for the applied voltage. Examples Bussman KTM or JJJ as appropriate.

2.4 Digital and Analog I/O Ratings

I/O	Scan Times	Linearity	Temperature Drift	Offset	Current	Input Impedance	Voltage Range
Units	µs	%	%	%	mA	Ohm	VDC
Digital Inputs⁽¹⁾	512				Depend on load	1.2 k	5-24
Digital Outputs	512				100 max	N/A	30 max
Analog Inputs	512	± 0.013	0.1% per °C rise	± 0 adjustable	Depend on load	47 k	± 10
Analog Outputs	512		0.1% per °C rise	± 0 adjustable	10 max	N/A	± 10

- (1) Inputs do not have scan time. Their values are read directly by indexer program statement.
De-bounce time is programmable and can be set as low as 0. Propagation delay is typical 20 us



2.5 Environment

Vibration	2 g (10 - 2000 Hz)
Ambient Operating Temperature Range	0 to 40°C (Derate rated output current and peak output current by 2.5% for every °C above 40°C up to 55°C)
Ambient Storage Temperature Range	-10 to 70°C
Temperature Drift	0.1% per °C rise
Humidity	5 - 90% non-condensing
Altitude	1500m/5000ft [derate by 1% per 300m (1000 ft) above 1500m (5000 ft)]

2.6 Operating Modes

Torque

Reference	± 10 VDC 12-bit; scalable
Torque Range	100:1
Current-Loop Bandwidth	Up to 1.5 kHz*

Velocity

Reference	± 10 VDC or 0...10 VDC; 12-bit; scalable
Regulation	± 1 RPM
Velocity-Loop Bandwidth	Up to 200 Hz*
Speed Range	5000:1 with 5000 ppr encoder

Position

Reference	0...2 MHz Step & Direction or 2 channels quadrature input; scalable
Minimum Pulse Width	500 nanoseconds
Loop Bandwidth	Up to 150 Hz*
Accuracy	±1 encoder count for encoder feedback ±1.32 arc-minutes for resolver feedback (14-bit resolution)

* = motor and application dependent

2.7 Connections and I/O

Mains Power	3-pin or 4-pin removable terminal block	(P1)
Ethernet Port	Standard RJ45 Connector	(P2)
I/O Connector	Standard 50-pin SCSI	(P3)
- Buffered Encoder Output	A, B, & Z channels with compliments (5V @ 20mA)	(P3)
- Digital Inputs	11 programmable plus 1 dedicated (5-24V)	(P3)
- Digital Outputs	4 programmable plus 1 dedicated (5-24V @ 100mA)	(P3)
- Analog Input	2 differential; ±10 VDC (12-bits each)	(P3)
- Analog Output	1 single ended; ±10 VDC (10-bit)	(P3)
- Position Reference Input	Step & Direction or Master Encoder (TTL)	(P3)
Encoder Feedback (E94P drive)	Feedback connector, 15-pin D-shell	(P4)
Resolver Feedback (E94R drive)	Feedback connector, 9-pin D-shell	(P4)
24VDC Power "Keep Alive"	2-pin removable terminal block	(P5)
Regen and Bus Power	5-pin removable terminal block	(P6)
Motor Power	6-pin pin removable terminal block	(P7)
ISO 13849-1 Safety Circuit (option)	6-pin quick connect terminal block	(P8)
RS485 Option Module	3-pin terminal block (installed in Option Bay 1)	(P21)
CAN Option Module	3-pin terminal block (installed in Option Bay 1)	(P21)
DeviceNet Option Module	5-pin terminal block (installed in Option Bay 1)	(P23)
PROFIBUS Option Module	9-pin D-shell connector (installed in Option Bay 1)	(P24)
MotionView OnBoard	Embedded Software (Java-based)	
Maximum Servo Cable Length	20 meters (10m if EN55011 compliance required, see 3.2.1)	



Technical Data

2.8 PositionServo Dimensions

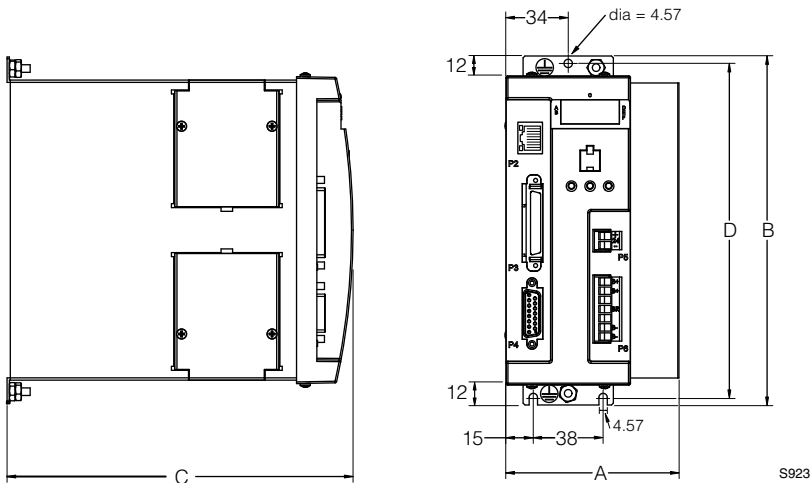

Type ⁽¹⁾	A (mm)	B (mm)	C (mm)	D (mm)	Weight (kg)
E94_020S1N_~	68	190	190	182	1.1
E94_040S1N_~	69	190	190	182	1.2
E94_020S2F_~	68	190	235	182	1.3
E94_040S2F_~	69	190	235	182	1.5
E94_080S2F_~	87	190	235	182	1.9
E94_100S2F_~	102	190	235	182	2.2
E94_020Y2N_~	68	190	190	182	1.3
E94_040Y2N_~	69	190	190	182	1.5
E94_080Y2N_~	95	190	190	182	1.9
E94_100Y2N_~	114	190	190	182	2.2
E94_120Y2N_~	68	190	235	182	1.5
E94_180T2N_~	68	242	235	233	2.0
E94_020T4N_~	68	190	190	182	1.5
E94_040T4N_~	95	190	190	182	1.9
E94_050T4N_~	114	190	190	182	2.2
E94_060T4N_~	68	190	235	182	1.4
E94_090T4N_~	68	242	235	233	2.0

- (1) The first "_" equals "P" for the Model 940 encoder based drive or "R" for the Model 941 resolver based drive. The second "_" equals "E" for incremental encoder (must have E94P drive) or "R" for the standard resolver (must have E94R drive).

The last digit "-" equals M" for MV OnBoard and no ISO 13849-1 circuit or "S" for MV OnBoard plus the ISO 13849-1 circuit.



Dimensions for Coldplate Drives

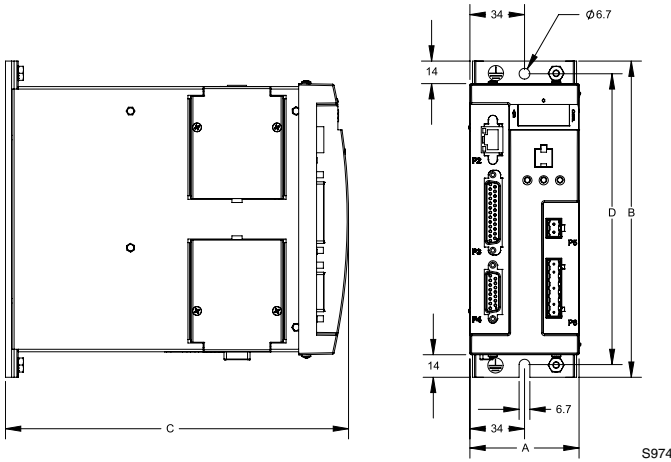

Type ⁽¹⁾	A (mm)	B (mm)	C (mm)	D (mm)	Weight (kg)
E94_120Y2C_~	68	197	214	182	1.4
E94_180T2C_~	68	248	193	232	1.7
E94_060T4C_~	68	197	214	182	1.5
E94_090T4C_~	68	248	193	232	1.7

- (1) The first "_" equals "P" for the Model 940 encoder based drive or "R" for the Model 941 resolver based drive. The 10th digit is marked by "C" to denote a Cold plate drive.
 The 11th digit marked by a "_" equals "E" for incremental encoder (must have E94P drive) or "R" for the standard resolver (must have E94R drive).
 The 12th (last) digit marked by a "_" equals "M" for MV OnBoard and no ISO 13849-1 circuit or "S" for MV OnBoard plus the ISO 13849-1 circuit.

2.9 Clearance for Cooling Air Circulation

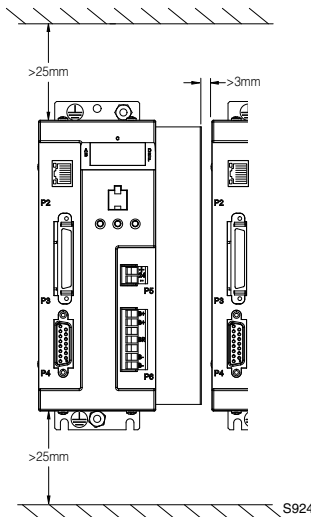



Installation

3 Installation

Perform the minimum system connection. Refer to section 6.1 for minimum connection requirements. Observe the rules and warnings below carefully:



DANGER!

Hazard of electrical shock! Circuit potentials are up to 480 VAC above earth ground. Avoid direct contact with the printed circuit board or with circuit elements to prevent the risk of serious injury or fatality. Disconnect incoming power and wait 60 seconds before servicing drive. Capacitors retain charge after power is removed.



STOP!

- The PositionServo must be mounted vertically for safe operation and to ensure enough cooling air circulation.
- Printed circuit board components are sensitive to electrostatic fields. Avoid contact with the printed circuit board directly. Hold the PositionServo by its case only.
- Protect the drive from dirt, filings, airborne particles, moisture, and accidental contact. Provide sufficient room for access to the terminal block.
- Mount the drive away from any and all heat sources. Operate within the specified ambient operating temperature range. Additional cooling with an external fan may be required in certain applications.
- Avoid excessive vibration to prevent intermittent connections
- DO NOT connect incoming (mains) power to the output motor terminals (U, V, W)! Severe damage to the drive will result.
- Do not disconnect any of the motor leads from the PositionServo drive unless (mains) power is removed. Opening any one motor lead may cause failure.
- Control Terminals provide basic isolation (insulation per EN 61800-5-1). Protection against contact can only be ensured by additional measures, e.g., supplemental insulation.
- Do not cycle mains power more than once every 2 minutes. Otherwise damage to the drive may result.



WARNING!

For compliance with EN 61800-5-1, the following warning applies.

This product can cause a d.c. current in the protective earthing conductor. Where a residual current-operated protective (RCD) or monitoring (RCM) device is used for protection in case of direct or indirect contact, only an RCD or RCM of Type B is allowed on the supply side of this product.



UL INSTALLATION INFORMATION

- Suitable for use on a circuit capable of delivering not more than 200,000 rms symmetrical amperes, at the maximum voltage rating marked on the drive.
- Use Class 1 wiring with minimum of 75°C copper wire only.
- Shall be installed in a pollution degree 2 macro-environment.



3.1 Wiring



DANGER!

Hazard of electrical shock! Circuit potentials are up to 480 VAC above earth ground. Avoid direct contact with the printed circuit board or with circuit elements to prevent the risk of serious injury or fatality. Disconnect incoming power and wait 60 seconds before servicing the drive. Capacitors retain charge after power is removed.



WARNING!

Leakage current may exceed 3.5mA AC. Minimum size of the protective earth conductor shall comply with local safety regulations for high leakage current equipment.



STOP!

Under no circumstances should power and control wiring be bundled together. Induced voltage can cause unpredictable behavior in any electronic device, including motor controls.



WARNING!

The PositionServo drive runs on phase-to-phase voltage. For the standard drive, either a delta or wye transformer may be used for 3-phase input. However, for reinforced insulation of user accessible I/O circuits, each phase voltage to ground must be less than or equal to 300VAC rms. This means that the power system must use center grounded wye secondary configuration for 400/480VAC mains.

Refer to section 4.1.1 for Power wiring specifications.

3.2 Shielding and Grounding

3.2.1 General Guidelines

Lenze recommends the use of single-point grounding (SPG) for panel-mounted controls. Serial grounding (a “daisy chain”) is not recommended. The SPG for all enclosures must be tied to earth ground at the same point. The system ground and equipment grounds for all panel-mounted enclosures must be individually connected to the SPG for that panel using 14 AWG (2.5 mm²) or larger wire.

In order to minimize EMI, the chassis must be grounded to the mounting. Use 14 AWG (2.5 mm²) or larger wire to join the enclosure to earth ground. A lock washer must be installed between the enclosure and ground terminal. To ensure maximum contact between the terminal and enclosure, remove paint in a minimum radius of 0.25 in (6 mm) around the screw hole of the enclosure.

Lenze recommends the use of the special PositionServo drive cables provided by Lenze. If you specify cables other than those provided by Lenze, please make certain all cables are shielded and properly grounded.

It may be necessary to earth ground the shielded cable. Ground the shield at both the drive end and at the motor end.

If the PositionServo drive continues to pick up noise after grounding the shield, it may be necessary to add an AC line filtering device and/or an output filter (between the drive and servo motor).



Installation

EMC

Compliance with EN 61800-3:2004

In a domestic environment this product may cause radio interference. The user may be required to take adequate measures

Noise emission

Drive Models ending in the suffix "2F" are in compliance with class A limits according to EN 55011 if installed in a control cabinet and the motor cable length does not exceed 10m. Models ending in "N" will require an appropriate line filter.

- A** Screen clamps
- B** Control cable
- C** Low-capacitance motor cable
(core/core < 75 pF/m, core/screen < 150 pF/m)
- D** Earth grounded conductive mounting plate
- E** Encoder/Resolver Feedback Cable
- F** Footprint or Sidemount Filter (optional)

Installation according to EMC Requirements

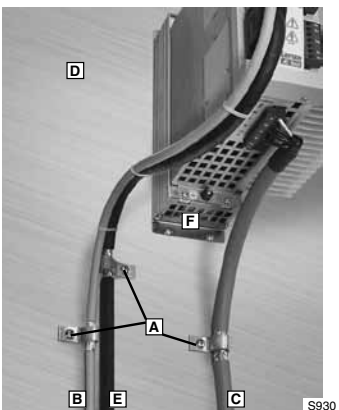

3.2.2 EMI Protection

Electromagnetic interference (EMI) is an important concern for users of digital servo control systems. EMI will cause control systems to behave in unexpected and sometimes dangerous ways. Therefore, reducing EMI is of primary concern not only for servo control manufacturers such as Lenze, but the user as well. Proper shielding, grounding and installation practices are critical to EMI reduction.

3.2.3 Enclosure

The panel in which the PositionServo is mounted must be made of metal, and must be grounded using the SPG method outlined in section 3.2.1.

Proper wire routing inside the panel is critical; power and logic leads must be routed in different avenues inside the panel.

You must ensure that the panel contains sufficient clearance around the drive. Refer to section 2.9 suggested cooling air clearance.

3.3 Line Filtering

In addition to EMI/RFI safeguards inherent in the PositionServo design, external filtering may be required. High frequency energy can be coupled between the circuits via radiation or conduction. The AC power wiring is one of the most important paths for both types of coupling mechanisms. In order to comply with IEC 61800-3:2004, an appropriate filter must be installed within 20cm of the drive power inputs.

Line filters should be placed inside the shielded panel. Connect the filter to the incoming power lines immediately after the safety mains and before any critical control components. Wire the AC line filter as close as possible to the PositionServo drive.

**NOTE**

The ground connection from the filter must be wired to solid earth ground, not machine ground.

If the end-user is using a CE-approved motor, the AC filter combined with the recommended motor and encoder feedback cables (maximum cable length of 10m), is all that is necessary to meet the EMC directives listed herein. The end user must use the compatible filter to comply with CE specifications. The OEM may choose to provide alternative filtering that encompasses the PositionServo drive and other electronics within the same panel. The OEM has this liberty because CE requirements are for the total system.

3.4 Heat Sinking

The PositionServo drive contains sufficient heat sinking within the specified ambient operating temperature in its basic configuration. There is no need for additional heat sinking. However, the user must ensure that there is sufficient clearance for proper air circulation. As a minimum, an air gap of 25 mm above and below the drive is necessary.

3.5 Line (Mains) Fusing

External line fuses must be installed on all PositionServo drives. Connect the external line fuse in series with the AC line voltage input. Use fast-acting fuses rated for 250 VAC or 600 VAC (depending on model), and approximately 200% of the maximum RMS phase current. Refer to section 2.3 for fuse recommendations.



4 Interface

The standard PositionServo drive is equipped with seven connectors including: four quick-connect terminal blocks, one SCSI connector, one subminiature type "D" connector and one ethernet RJ45 connector. These connectors provide communications from a PLC or host controller, power to the drive, and feedback from the motor. Prefabricated cable assemblies may be purchased from Lenze to facilitate wiring the drive, motor and host computer. Contact your Lenze Sales Representative for assistance.

As this manual makes reference to specific pins on specific connectors, the convention PX.Y is used, where X is the connector number and Y is the pin number.

4.1 External Connectors

4.1.1 P1 & P7 - Input Power and Output Power Connections

Located on the top of the drive, P1 is a 3 or 4-pin quick-connect terminal block used for input (mains) power. Located on the bottom of the drive, P7 is a 6-pin quick-connect terminal block used for output power to the motor. P7 also has a thermistor (PTC) input for motor over-temperature protection. The P1 and P7 connector pin assignments are listed in the tables herein.

P1 Pin Assignments (Input Power)

Standard Models			Doubler Models	
Pin	Name	Function	Name	Function
1	PE	Protective Earth (Ground)	PE	Protective Earth (Ground)
2	L1	AC Power in	N	AC Power Neutral (120V Doubler only)
3	L2	AC Power in	L1	AC Power in
4	L3	AC Power in (3- models only)	L2/N	AC Power in (non-doubler operation)

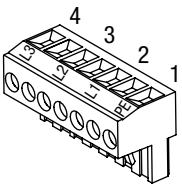

P7 Pin Assignments (Output Power)

Pin	Terminal	Function
1	T1	Thermistor (PTC) Input
2	T2	Thermistor (PTC) Input
3	U	Motor Power Out
4	V	Motor Power Out
5	W	Motor Power Out
6	PE	Protective Earth (Chassis Ground)

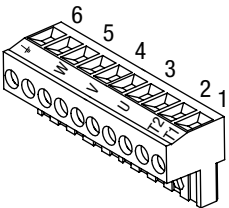

DANGER!

Hazard of electrical shock! Circuit potentials are up to 480 VAC above earth ground. Avoid direct contact with the printed circuit board or with circuit elements to prevent the risk of serious injury or fatality. Disconnect incoming power and wait 60 seconds before servicing drive. Capacitors retain charge after power is removed.



STOP!

DO NOT connect incoming power to the output motor terminals (U, V, W)! Severe damage to the PositionServo will result.

Check phase wiring (U, V, W) and thermal input (T1, T2) before powering up drive. If miswired, severe damage to the PositionServo will result.



All conductors must be enclosed in one shield with a jacket around them. The shield on the drive end of the motor power cable should be terminated to the conductive machine panel using screen clamps as shown in section 3.2. The other end should be properly terminated at the motor shield. Feedback cable shields should be terminated in a like manner. Lenze recommends Lenze cables for both the motor power and feedback. These are available with appropriate connectors and in various lengths. Contact your Lenze representative for assistance.

Wire Size

Current A (rms)	Terminal Torque (lb-in)	Wire Size
$I \leq 8$	4.5	16 AWG (1.5mm ²) or 14 AWG (2.5mm ²)
$8 < I \leq 12$	4.5	14 AWG (2.5mm ²) or 12 AWG (4.0mm ²)
$12 < I \leq 15$	4.5	12 AWG (4.0mm ²)
$15 < I \leq 20$	5.0 - 7.0	10 AWG (6.0mm ²)
$20 < I \leq 24$	11.0 - 15.0	10 AWG (6.0mm ²)

4.1.2 P2 - Ethernet Communications Port

P2 is a RJ45 Standard Ethernet connector that is used to communicate with a host computer via Ethernet TCP/IP.

P2 Pin Assignments (Communications)

Pin	Name	Function
1	+ TX	Transmit Port (+) Data Terminal
2	- TX	Transmit Port (-) Data Terminal
3	+ RX	Receive Port (+) Data Terminal
4	N.C.	
5	N.C.	
6	- RX	Receive Port (-) Data Terminal
7	N.C.	
8	N.C.	



NOTE

To communicate from the PC directly to the drive a crossover cable is recommended. If using a hub or switch, use a regular patch cable.



Interface

4.1.3 P3 - Controller I/O

P3 is a 50-pin SCSI connector to interface with the front-end of the controller. It is strongly recommended that OEM cables be used to aid in satisfying CE requirements. Contact your Lenze representative for assistance.

P3 Pin Assignments (Controller Interface)

Pin	Name	Function
1	MA+	Master Encoder A+ / Step+ input ⁽²⁾
2	MA-	Master Encoder A- / Step- input ⁽²⁾
3	MB+	Master Encoder B+ / Direction+ input ⁽²⁾
4	MB-	Master Encoder B- / Direction- input ⁽²⁾
5	GND	Drive Logic Common
6	5+	+5V output (max 100mA)
7	BA+	Buffered Encoder Output: Channel A+ ⁽¹⁾
8	BA-	Buffered Encoder Output: Channel A- ⁽¹⁾
9	BB+	Buffered Encoder Output: Channel B+ ⁽¹⁾
10	BB-	Buffered Encoder Output: Channel B- ⁽¹⁾
11	BZ+	Buffered Encoder Output: Channel Z+ ⁽¹⁾
12	BZ-	Buffered Encoder Output: Channel Z- ⁽¹⁾
13-19		Empty
20	AIN2+	Positive (+) of Analog signal input
21	AIN2-	Negative (-) of Analog signal input
22	ACOM	Analog common
23	AO	Analog output (max 10 mA)
24	AIN1+	Positive (+) of Analog signal input
25	AIN1 -	Negative (-) of Analog signal input
26	IN_A_COM	Digital input group ACOM terminal ⁽³⁾
27	IN_A1	Digital input A1
28	IN_A2	Digital input A2
29	IN_A3	Digital input A3 ⁽³⁾
30	IN_A4	Digital input A4
31	IN_B_COM	Digital input group BCOM terminal
32	IN_B1	Digital input B1
33	IN_B2	Digital input B2
34	IN_B3	Digital input B3
35	IN_B4	Digital input B4
36	IN_C_COM	Digital input group CCOM terminal
37	IN_C1	Digital input C1
38	IN_C2	Digital input C2
39	IN_C3	Digital input C3
40	IN_C4	Digital input C4
41	RDY+	Ready output Collector
42	RDY-	Ready output Emitter
43	OUT1-C	Programmable output #1 Collector
44	OUT1-E	Programmable output #1 Emitter
45	OUT2-C	Programmable output #2 Collector
46	OUT2-E	Programmable output #2 Emitter
47	OUT3-C	Programmable output #3 Collector
48	OUT3-E	Programmable output #3 Emitter
49	OUT4-C	Programmable output #4 Collector
50	OUT4-E	Programmable output #4 Emitter

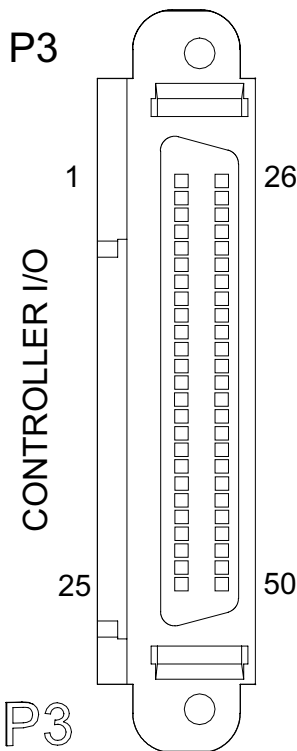

(1) Refer to Note 1, Section 4.1.7 - Connector and Wiring Notes

(2) Refer to Note 2, Section 4.1.7 - Connector and Wiring Notes

(3) Refer to Note 3, Section 4.1.7 - Connector and Wiring Notes



4.1.4 P4 - Motor Feedback

For encoder-based 940 drives, P4 is a 15-pin DB connector that contains connections for an incremental encoder with Hall emulation tracks or Hall sensors. For synchronous servo motors, Hall sensors or Hall emulation tracks are necessary for commutation. If an asynchronous servo motor is used, it is not necessary to connect Hall sensor inputs. For pin assignments, refer to the Table P4A. Encoder inputs on P4 have 26LS32 or compatible differential receivers for increased noise immunity. Inputs have all necessary filtering and line balancing components so no external noise suppression networks are needed.

For resolver-based 941 drives, P4 is a 9-pin DB connector for connecting resolver feedback and thermal sensor. For pin assignments, refer to the Table P4B. The resolver feedback is translated to 65,536 counts per revolution.

All conductors must be enclosed in one shield with a jacket around them. Lenze recommends that each and every pair (for example, EA+ and EA-) be twisted. In order to satisfy CE requirements, use of an OEM cable is recommended. Contact your Lenze representative for assistance.

The PositionServo buffers encoder/resolver feedback from P4 to P3. For example, when encoder feedback is used, channel A on P4, is Buffered Encoder Output channel A on P3. For more information on this refer to section 4.2.2 "Buffered Encoder Outputs".



STOP!

Use only +5 VDC encoders. Do not connect any other type of encoder to the PositionServo reference voltage terminals. When using a front-end controller, it is critical that the +5 VDC supply on the front-end controller NOT be connected to the PositionServo's +5 VDC supply, as this will result in damage to the PositionServo.



NOTE

- The PositionServo encoder inputs are designed to accept differentially driven hall signals. Single-ended or open-collector type hall signals are also acceptable by connecting "HA+", "HB+", "HC+" and leaving "HA-, HB-, HC-" inputs unconnected. The user does not need to supply pull-up resistors for open-collector hall sensors. The necessary pull-up circuits are already provided.
- Encoder connections (A, B and Z) must be full differential. The PositionServo does not support single-ended or open-collector type outputs from the encoder.
- An encoder resolution of 2000 PPR (pre-quadrature) or higher is recommended.



Interface

P4A Pin Assignments (Encoder Feedback - E94P Drives)

Pin	Name	Function
1	EA+	Encoder Channel A+ Input ⁽¹⁾
2	EA-	Encoder Channel A- Input ⁽¹⁾
3	EB+	Encoder Channel B+ Input ⁽¹⁾
4	EB-	Encoder Channel B- Input ⁽¹⁾
5	EZ+	Encoder Channel Z+ Input ⁽¹⁾
6	EZ-	Encoder Channel Z- Input ⁽¹⁾
7	GND	Drive Logic Common/Encoder Ground
8	SHLD	Shield
9	PWR	Encoder supply (+5VDC)
10	HA-	Hall Sensor A- Input ⁽²⁾
11	HA+	Hall Sensor A+ Input ⁽²⁾
12	HB+	Hall Sensor B+ Input ⁽²⁾
13	HC+	Hall Sensor C+ Input ⁽²⁾
14	HB-	Hall Sensor B- Input ⁽²⁾
15	HC-	Hall Sensor C- Input ⁽²⁾

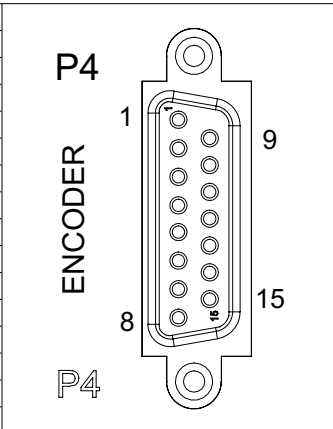

(1) Refer to Note 1, Section 4.1.7 - Connector and Wiring Notes

(2) For asynchronous servo motor, an incremental encoder without Hall effect sensors (commutation tracks) can be used.

P4B Pin Assignments (Resolver Feedback - E94R Drives)

Pin	Name	Function
1	Ref +	Resolver reference connection
2	Ref -	
3	N/C	No Connection
4	Cos+	Resolver Cosine connections
5	Cos-	
6	Sin+	Resolver Sine connections
7	Sin-	
8	PTC+	Motor PTC Temperature Sensor
9	PTC-	

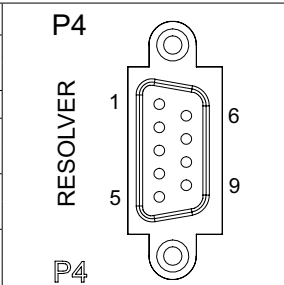

STOP!

Use only 10 V (peak to peak) or less resolvers. Use of higher voltage resolvers may result in feedback failure and damage to the drive.

4.1.5 P5 - 24 VDC Back-up Power Input

P5 is a 2-pin quick-connect terminal block that can be used with an external 24 VDC (500mA) power supply to provide “Keep Alive” capability: during a power loss, the logic and communications will remain active. Applied voltage must be greater than 20VDC.

P5 Pin Assignments (Back-up Power)

Pin	Name	Function
1	+24 VDC	Positive 24 VDC Input
2	Return	24V power supply return



WARNING!

Hazard of unintended operation! When the enable input remains asserted, the “Keep Alive” circuit will restart the motor upon restoration of mains power. If this action is not desired, then remove the enable input prior to re-application of input power.



4.1.6 P6 - Braking Resistor and DC Bus

P6 is a 5-pin quick-connect terminal block that can be used with an external braking resistor (the PositionServo has the regen circuitry built-in). The Brake Resistor connects between the Positive DC Bus (either P6.1 or 2) and P6.3.

P6 Terminal Assignments (Brake Resistor and DC Bus)

Pin	Terminal	Function	
1	B+	Positive DC Bus / Brake Resistor	B+
2	B+		B+
3	BR	Brake Resistor	BR
4	B-	Negative DC Bus	B-
5	B-		B-

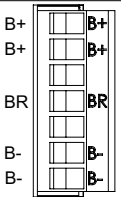

DANGER!

Hazard of electrical shock! Voltage up to 480 VAC above earth ground is possible. Avoid direct contact with live terminals and circuit elements. Disconnect incoming power and wait 60 seconds before opening or servicing the drive. Capacitors retain charge after power is removed.

4.1.7 Connector and Wiring Notes

Note 1 - Buffered Encoder Outputs

Each of the encoder output pins on P3 is a buffered pass-through of the corresponding input signal on P4. Refer to section 4.2.2 “Buffered Encoder Outputs”. This can be either from a motor mounted encoder or an encoder emulation of the resolver. The parameter “Resolver Tracks” configures the resolution of the encoder emulation (refer to 5.3.17).

Note 2 - Master Encoder Inputs or Step/Direction Inputs

An external pulse train signal (“step”) supplied by an external device, such as a PLC or stepper indexer, can control the speed and position of the servomotor. The speed of the motor is controlled by the frequency of the “step” signal, while the number of pulses that are supplied to the PositionServo determines the position of the servomotor. Direction input controls direction of the motion.

Note 3 - Digital Input A3

For the drive to function, an ENABLE input must be wired to the drive, and should be connected to IN_A3, (P3.29), which is, by the default the ENABLE input on the drive. This triggering mechanism can either be a switch or an input from an external PLC or motion controller. The input can be wired either sinking or sourcing (section 4.2.3). The Enable circuit will accept 5-24V control voltage.



Interface

Wiring the ENABLE Switch:

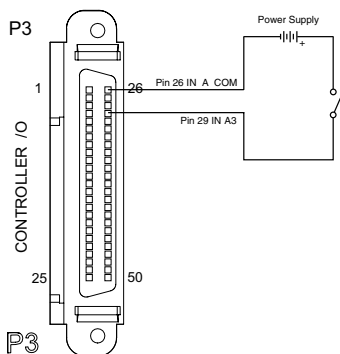
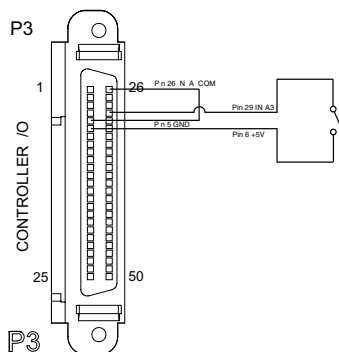

4.1.8 P8 - ISO 13849-1 Safety Circuit (option)

If installed, the ISO 13849-1 Safety Circuit connector, P8, is located on the bottom of the PositionServo. P8, a 6-pin quick-connect terminal block.

P8 Pin Assignments (ISO 13849-1 Safety Function)

Pin	Name	Function
1	Bypass Voltage	ISO 13849-1 Bypass Voltage (+24VDC)
2	Bypass COM	ISO 13849-1 Bypass Common
3	Safety Status	ISO 13849-1 Safety Status
4	Safety Input1	ISO 13849-1 Safety Input 1 (+24VDC to Enable)
5	Safety COM	ISO 13849-1 Safety Common
6	Safety Input2	ISO 13849-1 Safety Input 2 (+24VDC to Enable)

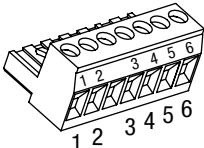

WARNING!

The drive is supplied from the factory with the ISO 13849-1 safety circuit enabled. The drive is not operational until +24V is present at terminals 4 and 6. For the proper safety connections, refer to the "Connection of Two Safety Circuits with External +24V Supply" diagram. Under certain applications when safety connections are not required the drive may be operated with the safety circuit disabled. The diagram below illustrates how to bypass the safety circuit.



Wiring Diagram to Bypass ISO 13849-1 Safety Circuit

Pin	Name	Function	
1	Bypass Voltage	ISO 13849-1 Bypass Voltage (+24VDC) ^{*1}	
2	Bypass COM	ISO 13849-1 Bypass Common ^{*1}	
3	Safety Status	ISO 13849-1 Safety Status	
4	Safety Input1	ISO 13849-1 Safety Input 1 (+24VDC to Enable) ^{*2}	
5	Safety COM	ISO 13849-1 Safety Common ^{*2}	
6	Safety Input2	ISO 13849-1 Safety Input 2 (+24VDC to Enable) ^{*2}	

*1 – This voltage must under no circumstances be used to supply the ISO 13849-1 Safety circuits (terminals 3 to 6). This voltage is intended only for use in bypassing (disabling) the ISO 13849-1 circuits should they not be required.

*2 – A Separate +24VDC supply, rated to ISO 13849-1 category 3 must be supplied to operate these inputs.

PositionServo drives with the following “S” designation in the model number have been fitted with the optional ISO 13849-1 Safe Torque Off function.

Drive Model Number:

E94	P	020	S	1	N	E	S
-----	---	-----	---	---	---	---	---

The last “S” denotes ISO 13849-1 option fitted to drive at manufacturer.

This option can only be fitted at the factory at the time of unit manufacturer.

This option provides additional methods (Inputs) to disable the drive output so that the drive cannot cause torque to be generated in the motor. This safety function is often referred to as the “Safe Torque Off” function and meets the requirements of the following standard: ISO 13849-1 Safety of Machinery, Safety-related Parts of Control Systems, Category (Cat.) 3, Performance Level (PL) d and Safety Integrity Level (SIL) 2, per EN 61800-5-2 2007.



WARNING!

It is required that all information contained within this ISO 13849-1 standard be observed when implementing any part of this safety circuit functionality with the PositionServo drive.

Operation of the ISO 13849-1 Safety Circuit

ISO 13849-1 Cat 3, PL d designates that the enable function of the drive be designed in such a way that a single fault in any of the parts of this enable circuit cannot lead to a loss of this safety function. The ISO 13849-1 safe torque off function has been designed and certified as meeting the requirements of this standard.

PositionServo drives equipped with the ISO 13849-1 safety circuit option can be used in application requiring conformance to this standard, and also in safety-related applications or in other applications where the integrity of the enable / disable function is paramount to the safety of personnel and machinery.

The ISO 13849-1 safety circuit can interrupt the power supply to the motor without the AC line input to the drive being removed. However, for the purposes of maintenance and mechanical work on the drive system it is recommended that the AC (work swap) Line input be removed and the drives internal bus voltages allowed to discharge before any such work is attempted. The ISO 13849-1 category 3 standard does not provide for electrical safety of all components within the drive system.



Interface

For normal operation (enable) of the PositionServo drive, both the Safety Input 1 and Safety Input 2 are required to be active. These inputs act as a Inhibit function, preventing the drive from being enabled until both are active, and causing the drive to disable once either one or both of the inputs are removed. The activation of both inputs will not automatically cause the drive to enable but will allow enable through the standard methods provided for enable of the drive.

If an attempt is made to enable the drive by executing the program statement “ENABLE” or from activating the input IN_A3 with the ISO 13849-1 safety inputs not being present then the drive will generate an ISO 13849-1 Safety Fault (F_EF).

When the drive is disabled through the ISO 13849-1 safety inputs (by removing the +24VDC assertion level to either Safety Input 1 or Safety Input 2 or both while the drive is enabled) the drive output is turned off and further torque cannot be produced by the drive in the motor. The drive will go to the “F_EF” fault condition to indicate disable of the drive was by means of the safety circuits. With the drive output disabled the motor will perform an uncontrolled stop or free-wheel deceleration to stand-still (unless driven by the load). Rotation of the motor will not stop immediately and the time to reach standstill will depend on the inertia contained within the system.



WARNING!

Ensure motion has stopped and the machine is in a safe condition before approaching the application.

If the system is required to be brought to zero speed on loss of the safety circuit function then a motor with a fail-safe mechanical brake should be used and the necessary mechanism implemented.

Due to ISO 13849-1 regulations, a separate +24VDC external dedicated safety power supply must be provided to the drive Safety circuits. The bypass +24V supply is intended for bypass purposes only and must not be used as the control voltage to these circuits.

Installation and Connection

Connection of Two Safety Circuits with External +24V Supply

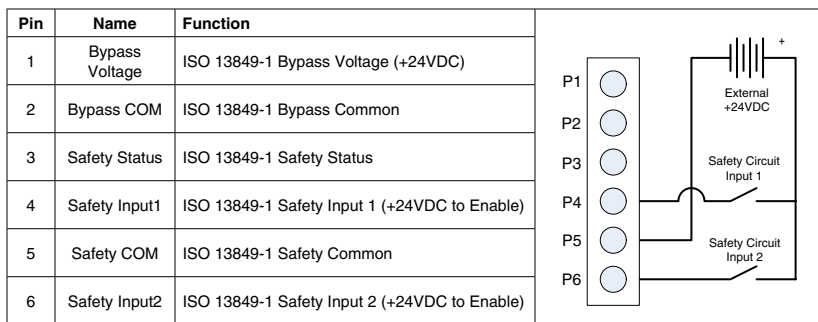

Evaluation and Testing of the ISO 13849-1 Safety Circuit

As part of the regulations for ISO 13849-1 safety circuit provision must be made for the user to periodically test the safety circuits and that testing should be capable of identifying a single fault. The PositionServo drive uses the safety status output (Pin 3) in conjunction with the display of the drive to allow the testing of the safety circuits.



The safety status output becomes active to indicate partial or full enable of the safety input circuits 1 and 2. If safety input 1 or safety input 2 or both inputs are on then the safety status output will become active. The safety status output must be connected to some visible indication for the operator to reference during test of the circuit.

As well as being used to test the correct operation of the safety circuits the safety status output can be used as an indicator that the drive has been placed in the fully shut down condition (all safety circuits off). For example, if both Safety Inputs have been Deactivated, the Safety Status is also Deactivated. If one of the Safety Inputs signals failed to call for a shutdown, or if one of the Safety Circuits failed to shut down, the Safety Status signal remains Asserted to alert the operator to the problem.

The procedure for testing the ISO 13849-1 safety circuit and the identification of a single fault on the system is given below. The safety status output should be connected to a visible indicator (such as a lamp or LED) so the operator can interpret its condition.

Connecting an Indicator to the Safety Status Output (Internal +24V supply)

Pin	Name	Function	
1	Bypass Voltage	ISO 13849-1 Bypass Voltage (+24VDC)	
2	Bypass COM	ISO 13849-1 Bypass Common	
3	Safety Status	ISO 13849-1 Safety Status	
4	Safety Input1	ISO 13849-1 Safety Input 1 (+24VDC to Enable)	
5	Safety COM	ISO 13849-1 Safety Common	
6	Safety Input2	ISO 13849-1 Safety Input 2 (+24VDC to Enable)	

Setting up the Drive in a Maintenance Mode:



WARNING!

During test of the ISO 13849-1 circuit, as laid out in this documentation the drive will go to run (enabled) condition and motion from the motor may be generated. It is the responsibility of the system designer to ensure the system remains in a safe condition during the enclosed maintenance procedure.

Guidance of setting up the drive to allow testing on the ISO 13849-1 circuit:

External Reference:

If the drive is getting its command signal from an external reference then Parameters should be set accordingly.

From the Parameter Folder:

Drive Operating Mode

Drive Mode:

Reference:

Drive PWM Frequency:

Fault Reset:

From the Digital IO Folder:

Enable Switch Function:

In this mode your external analog input will command movement. For safety purposes, measures should be made to sure that velocity is at a minimum. From here you can proceed to the ISO 13849-1 Test Procedure.



Interface

Internal Reference:

If an Indexer program is used to operate the drive then it must contain a means of placing the drive into a maintenance mode so that the ISO 13849-1 safety circuit can be safely tested. Responsibility lies with the programmer on the safe implementation of a maintenance mode within the indexer program.



WARNING!

If no maintenance mode has been incorporated into the Indexer program then the Indexer program must be erased prior to testing the ISO 13849-1 circuit. Save any code that is required but has not previously been saved and then delete all code from the indexer folder. Press the [Load W Source] button on the program toolbar to remove any residual code from the drive memory.

The following truth table shows logical conditions for ISO 13849-1 circuits.

Safety Input 1	Safety Input 2	Safety Status Output	Drive Display ^{*1}
1	1	1	Run
1	0	1	F_EF
0	1	1	F_EF
0	0	0	F_EF

*1 – Drive display will change to condition shown on enable of the drive (Input A3 Enable)

Place Input A3, hardware enable in the deactivated state.

Test Procedure for ISO 13849-1 Safety Circuit:

Test Step	Action	Drive Display Indication	Safety Status Output Indication	Failed Test Indication
1	Activate both safety circuit inputs 1 & 2. Set Input A3 to Enable	'Run'	'Activated'	Trip on display (F_EF) = one of the safety inputs failed to activate. Status Output Deactivated = Both Safety Inputs Failed to activate
2	Set Input A3 to Disable	'Dis'	'Activated'	Status Output Deactivated = Both Safety Inputs Failed to activate
3	Deactivate Safety Input 1. Set Input A3 to Enable	'F EF'	'Activated'	No Trip on display (F_EF) = Safety Input 1 failed to deactivate. Status Output Deactivated = Safety Input 2 Failed to activate
4	Activate Safety Input 1. Set Input A3 to disable	'Dis'	'Activated'	Status Output Deactivated = Both Safety Inputs Failed to activate
5	Deactivate Safety Input 2. Set Input A3 to Enable	'F EF'	'Activated'	No Trip on display (F_EF) = Safety Input 2 failed to deactivate. Status Output Deactivated = Safety Input 1 Failed to activate
6	Set Input A3 to disable	'Dis'	'Activated'	Status Output Deactivated = Both Safety Inputs Failed to activate
7	Deactivate Safety Input 1. Set Input A3 to Enable	'F EF'	'Deactivated'	No Trip on display (F_EF) = Safety Inputs 1 & 2 failed to deactivate. Status Output Activated = Safety Input 1 or Safety Input 2 Failed to deactivate



This procedure will evaluate the following conditions:

- All Circuits (safety inputs 1 & 2) working Correctly
- Safety Input 1 failing to activate
- Safety Input 1 failing to deactivate
- Safety Input 2 failing to activate
- Safety Input 2 failing to deactivate
- Both Safety input 1 and 2 failing to activate
- Both Safety input 1 and 2 failing to deactivate

Electrical Characteristics

Safety Input1, Safety Input2 and Safety Status are fully isolated from the rest of the drive circuits as shown in the following diagram.

Safety Inputs	Insulated, compatible with single-ended output (+24VDC) Enable voltage range: 18 to 30VDC Disable voltage range: 0 to 1.0 VDC
Input Impedance	6.8 k Ω
Safety Status	Isolated Open Collector (Grounded Emitter)
Output Load Capability	100mA
Output Max Voltage	30VDC (Collector-Emitter)

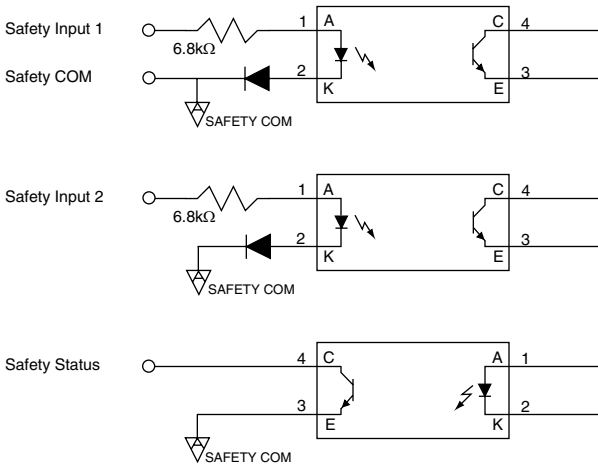



Interface

4.2 Digital I/O Details

4.2.1 Step & Direction/Master Encoder Inputs (P3, pins 1-4)

A master encoder with quadrature outputs or a step and direction pair of signals can be connected to the PositionServo to control position in the external positioning operating mode. These inputs are optically isolated from the rest of the drive circuits and from each other. Both inputs can operate from any voltage source in the range of 5 to 24 VDC and do not require additional series resistors for normal operation.

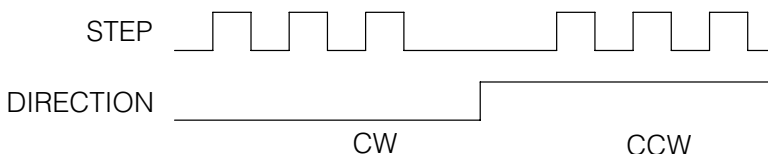

Timing Diagram for Step & Direction Signals

S904

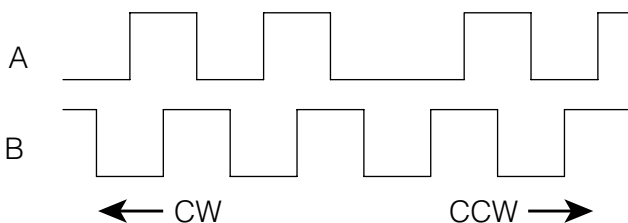

S905

Timing Diagram for Master Encoder Signals

Input type/ output compatibility	Insulated, compatible with Single-ended or differential outputs (5-24 VDC)
Max frequency (per input)	2 MHz
Min pulse width (negative or positive)	500nS
Input impedance	700 Ω (approx)

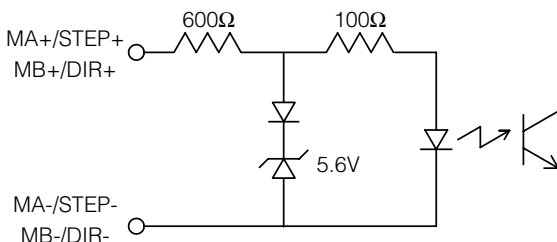

S906

Master Encoder Step & Direction Input Circuit

Differential signal inputs are preferred when using Step and Direction. Single ended inputs can be used but are not recommended. Sinking or sourcing outputs may also be connected to these inputs. The function of these inputs “Master Encoder” or “Step and Direction” is software selectable. Use the MotionView set up program to choose the desirable function.



4.2.2 Buffered Encoder Output (P3, pins 7-12)

There are many applications where it is desired to close the feedback loop to an external device. This feature is built into the PositionServo drive and is referred to as the “Buffer Encoder Output”. If a motor with encoder feedback is being used, the A+, A-, B+, B-, Z+ and Z- signals are directly passed through the drive through pins 7-12 with no delays, up to a speed of 2MHz. If a motor with resolver feedback is being used a minimal encoder feedback is transmitted. The default resolution of the simulated encoder is 1024 pulses per revolution, pre-quad. If a different resolution is desired refer to section 5.3.19 “Resolver Tracks”. There is a small additional delay when using a resolver. With Encoder pass through the delay is approximately 100nS; with Resolver pass through, the delay is approximately 62uS. Refer to Note 1 in section 4.1.7.

4.2.3 Digital Outputs

There are a total of five digital outputs (“OUT1” - “OUT4” and “RDY”) available on the PositionServo drive. These outputs are accessible from the P3 connector. Outputs are open collector/emitter and are fully isolated from the rest of the drive circuits as shown in the figures below. These outputs can be used by the drive’s internal User Program or they can be configured as Special Purpose outputs. When used as Special Purpose, each output (OUT1-OUT4) can be assigned to one of the following functions:

- Not assigned
- Zero speed
- In-speed window
- Current limit
- Run-time fault
- Ready
- Brake (motor brake release)

Note that if an output is assigned as a Special Purpose Output then that output can **not** be utilized by the User Program. The “RDY” Output has a fixed function, “ENABLE”, that will become active when the drive is enabled and the output power transistors become energized.

Digital outputs electrical characteristics

Circuit type	Isolated open collector/emitter
Digital outputs load capability	100mA
Digital outputs Collector-Emitter max voltage	30V

The digital outputs have a typical 1 volt leakage. Apply the appropriate relays based on the application. The outputs on the drive can be wired as either sinking (NPN) or sourcing (PNP), as illustrated herein.

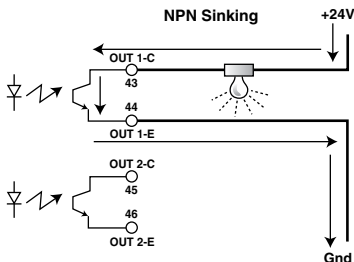

mb101

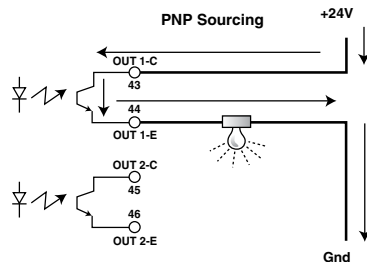

mb102



4.2.4 Digital Inputs

IN_Ax, IN_Bx, IN_Cx (P3.26-30, P3.31-35, P3.36-40)

The PositionServo drive has 12 optically isolated inputs. These inputs are compatible with a 5 - 24V voltage source. No additional series resistors are needed for circuit operation. The 12 inputs are segmented into three groups of 4, Inputs A1 - A4, Inputs B1 - B4, and Inputs C1 - C4. Each group, (A, B and C) have their own corresponding shared COM terminal, (ACOM, BCOM and CCOM). Each group or bank can be wired as sinking or sourcing. Refer to the PNP Sourcing and NPN Sinking wiring examples herein. All inputs have a separate software adjustable de-bounce time. Some of the inputs can be set up as Special Purpose Inputs. For example, inputs A1 and A2 can be configured as hardware limit switch inputs, input A3 is always set up as an Enable input and input C3 can be used as a registration input. Refer to the PositionServo Programming Manual for more detail.

For the registration input (C3), the registration time is $3\mu\text{s}$ for an encoder and $7\mu\text{s}$ for a resolver.

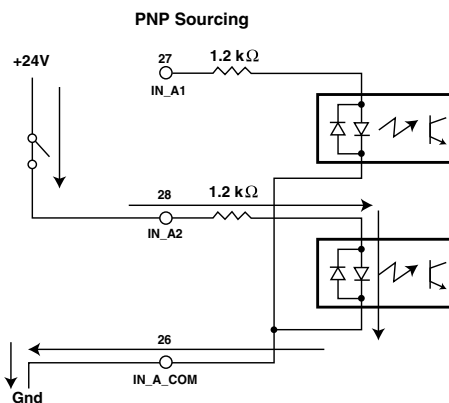

Digital inputs circuit.

mb103

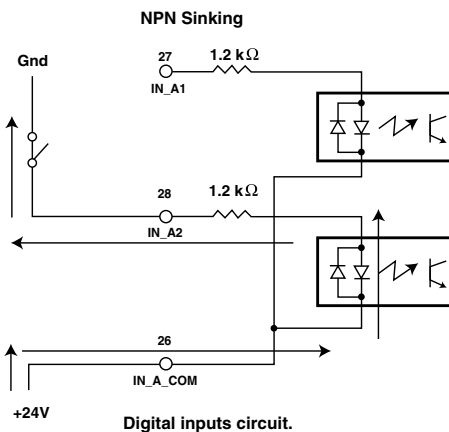

Digital inputs circuit.

mb104



4.3 Analog I/O Details

4.3.1 Analog Reference Input

AIN1+, AIN1- (P3.24 and P3.25)

The analog reference input can accept up to a $\pm 10\text{V}$ analog signal across AIN1+ and AIN1-. The maximum limit with respect to analog common (ACOM) on each input is $\pm 18\text{VDC}$. The analog signal will be converted to a digital value with 12 bit resolution (11-bit plus sign). This input is used to control speed or torque of the motor in velocity or torque mode. The total reference voltage as seen by the drive is the voltage difference between AIN1+ and AIN1-. If used in single-ended mode, one of the inputs must be connected to a voltage source while the other one must be connected to Analog Common (ACOM). If used in differential mode, the voltage source is connected across AIN1+ and AIN1- and the driving circuit common (if any) needs to be connected to the drive Analog Common (ACOM) terminal. Refer to the External Reference and Single-Ended Configuration wiring examples below.

Reference as seen by drive: $V_{\text{ref}} = (\text{AIN1+}) - (\text{AIN1-})$ and $-10\text{V} \leq V_{\text{ref}} \leq +10\text{V}$

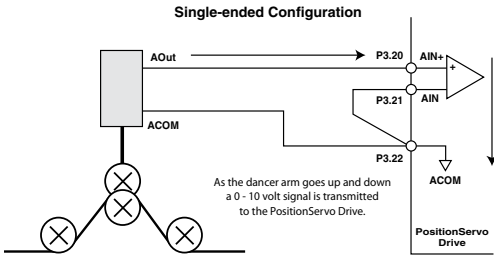
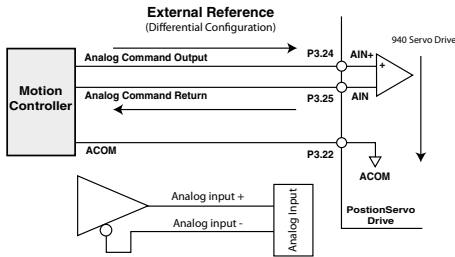

AIN2+, AIN2- (P3.20 and P3.21)

The analog reference input can accept up to a $\pm 10\text{V}$ analog signal across AIN2+ and AIN2-. The maximum limit with respect to analog common (ACOM) on each input is $\pm 18\text{VDC}$. The analog signal will be converted to a digital value with 12 bit resolution (11-bit plus sign). This input is available to the User's program. This input does not have a predefined function.



Interface

4.3.2 Analog Output

AO (P3.23)

The analog output is a single-ended signal (with reference to Analog Common (ACOM)) which can represent the following motor data:

- Not Assigned
- Phase R Current
- Iq Current
- RMS Phase Current
- Phase S Current
- Id Current
- Peak Phase Current
- Phase T Current
- Motor Velocity

Motor phase U, V and W correspond to R, S and T respectively.

MotionView Setup program can be used to select the signal source for the analog output as well as its scaling.

If the output function is set to “Not Assigned” then the output can be controlled directly from user’s program. Refer to the PositionServo Programming Manual for details.



STOP!

Upon application of power to the PositionServo, the Analog Output supplies -10VDC until bootup is complete. Once bootup is complete, the Analog Output will supply the commanded voltage.

4.4 Communication Interfaces

4.4.1 Ethernet Interface (standard)

Programming and diagnostics of the drive are performed over the standard Ethernet communication port. The drive’s IP address is addressable from the drive’s front panel display. The interface supports both 100 BASE-TX as well as 10 BASE-T. This configuration allows the user to monitor and program multiple drives from MotionView. Refer to section 5.4.1 for PC configuration information.

4.4.2 RS485 Interface (option)

PositionServo drives can be equipped with an RS485 communication interface option module (E94ZARS41) that is optically isolated from the rest of the drive’s circuitry. The option module can be used for communications to the drive as a Modbus RTU slave or over UPPP protocol. The PositionServo drive supports 7 different baud rates from 2400 to 115200. As a Modbus RTU slave, drives are addressable at up to 247 addresses (repeaters are required above 31 devices on the network). The factory setting for the baud rate is 38,400 with a node address of “1”. The drive’s address and baud rate can be set from the front panel of the drive or in MotionView.

RS485 Interface Pin Assignments

Pin	Name	Function	
1	ICOM	Isolated Common	
2	TXB	Transmit B(+)	
3	TXA	Transmit A(-)	



4.4.3 Modbus RTU Support

The RS485 interface is configured through the MotionView program. When configured for Modbus operation, the baud rate for RS485 is set using the parameter “RS485 baud rate”. Modbus RTU requires 8 data bits. The Modbus RTU slave interface protocol definitions can be found on the MotionView CD in “Product Manuals”, P94MOD01.



NOTE

Only one communication option module (RS485, CANopen, DeviceNet or PROFIBUS DP) can be installed in the Option Bay 1 at a time. The COMM modules can be exchanged out and replaced with another of a different type. The Ethernet interface supports Modbus TCP/IP and EtherNet/IP.

4.4.4 CANopen Interface

An optional CANopen communication module (E94ZACAN1) is available for the PositionServo drive. Installed in Option Bay 1 as P21, the CANopen module is optically isolated from the rest of the drive’s circuitry. The 3-pin CANopen module is for HW/SW 1A10 and the 5-pin CANopen module is for HW/SW 1B10 or higher. Refer to the PS CANopen Reference Guide (P94CAN01) for more information.

CANopen Interface Pin Assignments

Pin	Name	Function	Pin	Name	Function
1	ICOM	Isolated Common	1	NC	No connection
2	CAN L	CAN Bus Low	2	CAN H	CAN Bus High
3	CAN H	CAN Bus High	3	Shield	
			4	CAN L	CAN Bus Low
			5	NC	No connection

4.4.5 DeviceNet Interface

An optional DeviceNet communication module (E94ZADV1) is available for the PositionServo drive. Installed in Option Bay 1 as P23, the DeviceNet module is optically isolated from the rest of the drive’s circuitry. The DeviceNet module is a 5-pin quick connect terminal block. Refer to the PS DeviceNet Communications Reference Guide (P94DVN01) for detailed information.

DeviceNet Interface Pin Assignments

Pin	Name	Function
1	V-	0V
2	CAN L	CAN Bus Low (Negative data line)
3	Shield	
4	CAN H	CAN Bus High (Positive data line)
5	V+	11-25VDC power supply



Interface

4.4.6 PROFIBUS DP Interface

An optional PROFIBUS DP communication module (E94ZAPFB1) is available for the PositionServo drive. Installed in Option Bay 1 as P24, the PROFIBUS DP module is optically isolated from the rest of the drive's circuitry. The PROFIBUS module is a female DB-9 connector. Refer to the PS PROFIBUS Communications Reference Guide (P94PFB01) for detailed information.

Pin	Name	Function
1	Shield	Cable Shield Connection
2	N/C	No Connection
3	RxD/TxD-P	Data Line B (Red)
4	N/C	No Connection
5	DGND	Data Ground
6	+5V	5V Output Supply
7	N/C	No Connection
8	RxD/TxD-N	Data Line A (Green)
9	N/C	No Connection

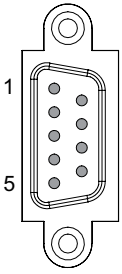

4.5 Motor Selection

The PositionServo drive is compatible with many 3-phase AC synchronous servo motors. MotionView OnBoard is equipped with a motor database that contains hundreds of motors for use with the PositionServo drive. If the desired motor is in the database, no data is needed to set it up. Just select the motor and click "OK". However, if the motor is not in the database, it can still be used, but some electrical and mechanical data must be provided to create a custom motor profile. The auto-phasing feature of the PositionServo drive allows the user to correctly determine the relationship between phase voltage and hall sensor signals or resolver offset, eliminating the need to determine feedback orientation by other means.

4.5.1 Motor Connection

Motor phase U, V, W (or R, S, T) are connected to terminal P7. It is very important that motor cable shield is connected to Earth ground terminal (PE) or the drive's case. The motor's encoder/resolver feedback cable must be connected to terminal P4.

4.5.2 Motor Over-Temperature Protection

If using a motor equipped with an encoder and PTC thermal sensor, the encoder feedback cable will have flying leads exiting the P4 connector to be wired to the P7.1 (T1) and P7.2 (T2) terminals. If using a motor equipped with a Resolver and a PTC sensor, the thermal feedback is passed directly to the drive via the resolver 9-pin D shell connector.

Use parameter "Motor PTC cut-off resistance" (section 5.3.10) to set the resistance that corresponds to maximum motor allowed temperature. The parameter "Motor temperature sensor" must also be set to ENABLE. If the motor doesn't have a PTC sensor, set this parameter to DISABLE. This input will also work with N.C. thermal switches which have only two states; Open or Closed. In this case "Motor PTC cut-off resistance" parameter can be set to the default value.



5 Parameters

The PositionServo drive has many programmable features accessible via the universal software MotionView. This chapter covers the drive's programmable features and parameters in the order they appear in the Parameter Tree of MotionView. Programmable parameters are divided into folders. Each folder contains one or more user adjustable parameters.

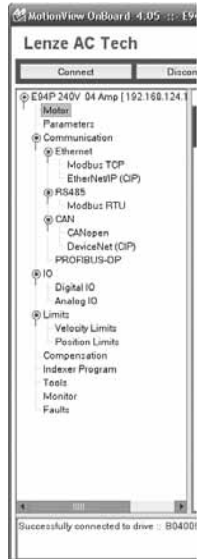

Parameter (Node) Tree

All drives can execute a User Program in parallel with motion. Motion can be specified by variety of sources and in three different modes:

Torque

Velocity

Position

In Torque and Velocity mode the reference can be taken from Analog Input AIN1 or from the User Program by setting a particular variable (digital reference). In Position mode, the reference can be taken from MA/MB master encoder/step and directions inputs (available in terminal P3) or from trajectory generator. Access to the trajectory generator is provided through the User Program's motion statements, MOVEx and MDV. Refer to the PositionServo Programming Manual for details on programming. Whether the reference comes from an external device, (AIN1 or MA/MB) or from the drives internal variables (digital reference and trajectory generator) will depend on the parameter settings.



5.1 Drive Identification

At the top of the Node Tree, click the Drive name [E94P 240V 04Amp ...]. The drive ID string, device family, firmware revision, vector processor revision, hardware revision, MotionView OnBoard revision, motor database revision, indexer compiler revision, serial number, drive name and group ID are displayed as illustrated herein. With the exception of the Drive Name and Group ID, the drive identification parameters are fixed and provided for information only.

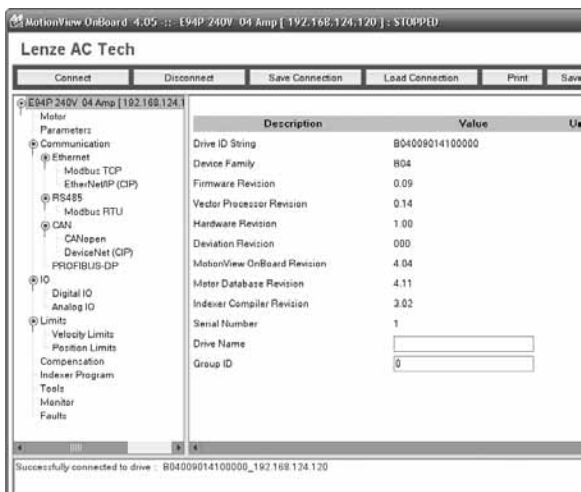

The drive identifier (E94P 240V 04Amp [192.168.124.120] : STOPPED) in the node tree consists of three segments: the drive's name, the drive's IP address and the status of the Indexer Program.

Drive name: E94P 240V 04Amp
Drive IP address: 192.168.124.120
Indexer program status: STOPPED (indexer program is stopped)
RUNNING (indexer program is running)

The drive identifier also indicates the status of the drive. When the drive identifier in the node tree is highlighted in green, the drive is enabled. When the drive identifier is gray, the drive is disabled.

5.1.1 Drive Name

To assign a name to the drive click in the box adjacent to Drive Name. A alpha-numeric name may be entered to identify the drive.

5.1.2 Group ID

The Group ID feature allows the user to group PositionServo drives together via an Ethernet network. When used with the SEND and SENDTO command, drives in the same group can share and update variables. Group ID Numbers can be set between 0 and 32767. See statements SEND and SENDTO for further explanations.



5.2 Motor

The motor folder displays the data for the currently selected motor. A motor may be selected from the database or a custom motor may be configured.

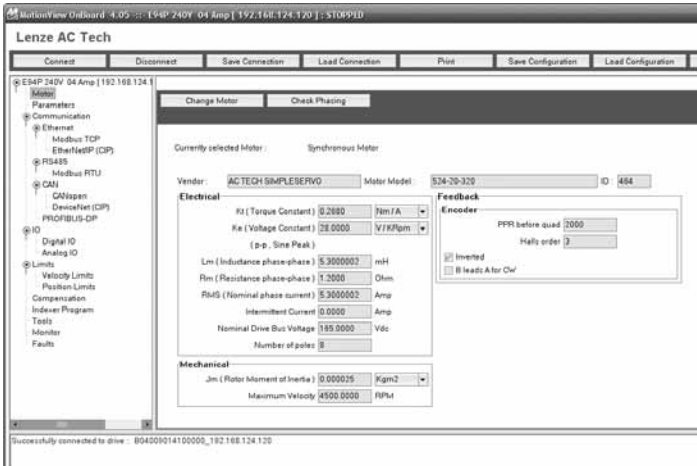

5.2.1 Motor Setup

Select the [Motor] folder in the right-hand “Parameter View Window”. To select a new motor click the [Change Motor] button. When [Change Motor] is selected, the Motor Database dialog box will open. Select the Motor Type from the node tree in the left-hand window.



NOTE: The drive must be is DISABLED (display: “d ,5”) to setup a new motor.

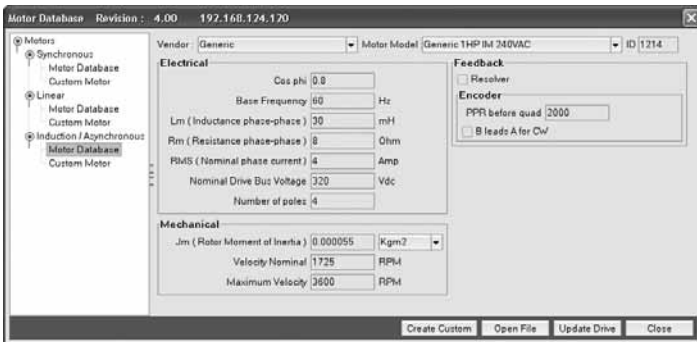

To make a new motor selection:

- Click [Change Motor] in the Parameter View Window.
- Select motor Vendor and Motor Model from the pull down menus.
- Click [Update Drive] to complete the motor selection, dismiss the dialog box and return to MotionView OnBoard’s main program.
- If using a motor not listed in the current motor database, select [Create Custom] and refer to section 5.2.2 “Using a Custom Motor”.



Parameters



NOTE

To help prevent the motor from drawing too much current and possibly overheating it is recommended that the drive's "Current Limit" be checked against the motor's "Nominal Phase Current" and set accordingly.

5.2.2 Using a Custom Motor

Follow these instructions to load a custom motor from a file or create a new custom motor. From the Parameter tree select the [Motor] folder. From the Parameter view window select [Change Motor].

- With the Motor Database dialog box open, Click [Custom Motor] under the Motor Type from the left-hand window: Synchronous or Induction/Asynchronous.
- Input the Motor data manually or from a previously saved motor file. To load motor data from a file click [Open file], select file path and click [OK] to open.
- To add this new custom file to your computer's hard drive, click [Save File], select file path and click [OK] to save.
- To load this file to the drive, click [Update Drive].
- When selecting [OK] for a custom motor, a dialog box will appear prompting for a decision to perform/not perform "Autophasing" (refer to section 5.2.4).

5.2.3 Creating Custom Motor Parameters



STOP!

Use extreme caution when entering custom parameters! Incorrect settings may damage the drive or motor! If unsure of the settings, refer to the materials distributed with the motor, or contact the motor manufacturer for assistance.

1. Enter custom motor data in the Motor Parameters dialog fields. Complete all sections of dialog: Electrical, Mechanical, Feedback and Motor Gain Scaling.



NOTE

If unsure of the motor halls order and encoder channels A and B relationship, leave "B leads A for CW", "Halls order" and "inverted" fields as they are. Use Autophasing (section 5.2.4) to set them correctly.

2. Enter motor model and vendor in the top edit boxes. Motor ID cannot be entered, this is set to 0 for custom motors. Likewise, if unsure of resolver offset and direction of rotation leave at default and correct using the Autophasing.
3. Click [Save File] button and enter filename without extension. The default extension .cmt will be given when you click OK on file dialog box.

**NOTE**

Save the file even if the autophasing feature will be used and some of the final parameters are not known. After autophasing is completed, the corrected motor file can be updated before loading it to memory.

4. Click [Close] to exit from the Motor Parameters dialog.
5. MotionView will prompt to autophase/not autophase the custom motor. Answer [No] to cancel without applying the changes made in the Motor database window. Answer [Yes] and the motor dialog will be dismissed and the drive will start the autophasing sequence. Refer to section 5.2.4, Autophasing.
6. If [Yes] is selected, the same motor selection dialog box will be displayed after autophasing is complete. For motors with incremental encoders, the fields “B leads A for CW”, “Halls order” and “inverted” will be assigned correct values. For motors with resolvers, the fields “Offset in degree” and “CW for positive” will be assigned correct values.
7. Click [Save File] to save the custom motor file and then click [Update Drive] to exit the dialog box and load the data to the drive.

5.2.4 Autophasing



NOTE: Autophasing is not needed and does not function with induction motors.

The Autophasing feature determines important motor parameters when using a motor that is not in MotionView’s database. For motors equipped with incremental encoders, Autophasing will determine the Hall order sequence, Hall sensor polarity and encoder channel relationship (B leads A or A leads B for CW rotation). For motors equipped with resolvers, Autophasing will determine resolver angle offset and angle increment direction (“CW for positive”).

To perform autophasing:

1. Complete the steps in “Creating custom motor parameters”. If the motor file to be autophased already exists, simply load it as described under “Using a custom motor”.
2. Make sure that the motor’s shaft is not connected to any mechanical load and can freely rotate.

**STOP!**

Autophasing will energize the motor and will rotate the shaft. Make sure that the motor’s shaft is not connected to any mechanical load and can freely and safely rotate.

3. **Make sure that the drive is not enabled.**
4. For Encoder it is not necessary to edit the field “Hall order” and check boxes “inverted” and “B leads A for CW” as these values are ignored for autophasing. For Resolver it is not necessary to set “Offset in degree” and “CW for positive”.
5. Click [Update Drive] to dismiss motor selection dialog. MotionView responds with the question “Do you want to perform autophasing?”
6. Click [OK]. A safety reminder dialog appears. Verify that it is safe to run the motor then click [Yes] and wait until autophasing is completed.

**NOTE**

If a problem occurs with the motor, hall sensor or resolver connections, MotionView will send an error message. The source of the error is commonly the power, shield and ground terminations or the use of an improper cable. Correct the wiring problem(s) and repeat steps 1 - 6.

If the error message repeats, exchange motor phases U and V (R and S) and repeat. If problems persist, contact the factory.



Parameters

- If autophasing is completed with no error then MotionView will return to the motor dialog box. For motors with incremental encoders, the parameter field “Hall order” and the check boxes “inverted”, “B leads A for CW” will be filled in with correct values. For resolver equipped motors, fields “Offset” and “CW for positive” will be correctly set.
- Click [Save File] to save the completed motor file (use same filename as the initial data in step 1). Click [Update Drive] to load the motor data to the drive.

5.2.5 Custom Motor Data Entry

A Custom Motor file is created by entering motor data into the “Motor Parameters” dialog box. This box is divided up into four sections: Electrical constants, Mechanical constants, Feedback and Gain Scaling.

Parameter Type	Synchronous Motor	Asynchronous (Induction) Motor
Identification	Vendor, Motor Model, ID	Vendor, Motor Model, ID
Electrical	K_t , K_e , L_m , R_m , I_{RMS}^* , Nominal V_{BUS}^* , # of poles	$\cos \phi$, f_{BRUSH}^* , L_m , R_m , I_{RMS}^* , Nominal V_{BUS}^* , # of poles
Feedback	Primary feedback, Resolver Offset	Resolver FB, Encoder PPR before quad, B leads A CW
Motor Gain Scaling	Velocity P-gain, Velocity I-gain, Gain Scaling	Velocity P-gain, Velocity I-gain, Gain Scaling
Mechanical	J_m , Vel_{MAX}	J_m , $Vel_{NOMINAL}^*$, Vel_{MAX}

When creating a custom motor, input the value of all parameters listed for the specific motor type. All entries are mandatory except motor inertia (J_m). Enter a value of 0 for the motor inertia if the actual value is unknown.

5.2.5.1 Electrical & Mechanical Constants

Motor Torque Constant (K_t)

Enter the value and select proper units from the drop-down list.

**NOTE**

Round the calculated result to 3 significant places.

Motor Voltage Constant (K_e)

The program expects K_e to be entered as a phase-to-phase Peak voltage. If you have K_e as an RMS value, multiply this value by 1.414 for the correct K_e Peak value.

Phase-to-phase winding Inductance (L_m)

This must be set in millihenries (mH). The phase-to-phase winding Inductance (L) will typically be between 0.1 and 200.0 mH.

**NOTE**

If the units for the phase-to-phase winding Inductance (L) are given in micro-henries (μH), then divide by 1000 to get mH.

Phase-to-phase winding Resistance (R_m) in Ohms

This is also listed as the terminal resistance (R_t). The phase-to-phase winding Resistance (R) will typically be between 0.05 and 200 Ohms.

Nominal phase current (RMS Amps)

Nominal continuous phase current rating (I_n) in Amps RMS. Do not use the peak current rating.



NOTE

If the phase current rating is not given, use this equation to obtain the nominal continuous phase-to-phase winding current:

$$I_n = \text{Continuous Stall Torque} / \text{Motor Torque Constant (Kt)}$$

The same force x distance units must be used in the numerator and denominator in the equation above. If torque (T) is expressed in units of pound-inches (lb-in), then Kt must be expressed in pound-inches per Amp (lb-in/A). Likewise, if T is expressed in units of Newton-meters (N-m), then units for Kt must be expressed in Newton-meters per Amp (N-m/A).

Example:

Suppose that the nominal continuous phase to phase winding current (I_n) is not given. Instead, we look up and obtain the following:

Continuous stall torque $T = 3.0$ lb-in

Motor torque constant $K_t = 0.69$ lb-in/A

Dividing, we obtain:

$$I_n = 3.0 \text{ lb-in} / 0.69 \text{ lb-in/A} = 4.35 \text{ (A)}$$

Our entry for (I_n) would be 4.35.

Note that the torque (lb-in) units are cancelled in the equation above leaving just Amps (A). We would have to use another conversion factor if the numerator and denominator had different force x distance units.

Nominal Bus Voltage (V_{bus})

The Nominal Bus Voltage can be calculated by multiplying the Nominal AC mains voltage supplied by 1.41. When using a model with the suffix "S1N" where the mains are wired to the "Doubler" connection, the Nominal Bus Voltage will be doubled.

Example:

If the mains voltage is 230VAC, $V_{bus} = 230 \times 1.41 = 325V$

This value is the initial voltage for the drive and the correct voltage will be calculated dynamically depending on the drive's incoming voltage value.

Number of Poles

This is a positive integer number that represents the number of motor poles, normally 2, 4, 6 or 8.

Rotor Moment of Inertia (J_m)

From motor manufacturer or nameplate.



NOTE

Round the calculated result to 3 significant places.



Parameters

5.2.5.2 For Incremental Encoder - Equipped Motors Only

Encoder Line Count

The encoders for servomotors normally have line counts of 1000, 1024, 2000, 2048, 4000, or 4096. The Encoder Line Count is pre-quadrature and a positive integer.

Halls Order

Each hall signal is in phase with one of the three phase-phase voltages from the motor windings. Hall order number defines which hall sensor matches which phase-phase voltage. Motor phases are usually called R-S-T or U-V-W or A-B-C. Phase-Phase voltages are called V_{rs} , V_{st} , V_{tr} . Halls are usually called HALL-A, HALL-B, HALL-C or just Halls 1, 2, 3. A motor's phase diagram is supplied by motor vendor and usually can be found in the motor data sheet or by making a request to the motor manufacturer. A sample phase diagram is illustrated in Figure S912.

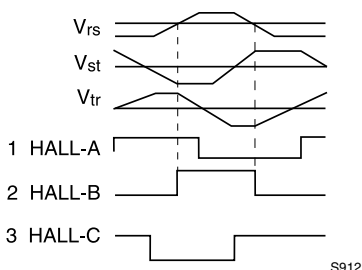

The Halls Order is obtained as follows:

1. Look at the " V_{rs} " Output Voltage and determine the Hall Voltage that is lined up with (or in phase with) this voltage. To determine which Hall Voltage is in phase with the V_{rs} Output Voltage draw vertical lines at those points where it crosses the horizontal line (zero). The dashed lines at the zero crossings (above) indicate that Hall B output is lined up with (and in phase with) the V_{rs} Output Voltage.
2. Look at the " V_{st} " Output Voltage. Determine which Hall Voltage is in phase with this Voltage. Per Figure S912, the Hall C output is in phase with the V_{st} Output Voltage.
3. Look at the " V_{tr} " Output Voltage. Determine which Hall Voltage is in phase with this Voltage. Per Figure S912, the Hall A output is in phase with the V_{tr} Output Voltage.



NOTE

If hall sensors are in phase with the corresponding phase voltage but are inverted 180 degrees (hall sensor waveform edge aligns with the phase-phase voltage waveform but the positive hall sensor cycle matches the negative phase-phase waveform or visa-versa), you must check the "Inverted" check box.

4. The phases that correspond to the V_{rs} , V_{st} and V_{tr} voltages are Hall B then Hall C then Hall A or Halls number 2 then 3 then 1. Referring to the following table, we find that 2-3-1 sequence is Halls Order number 3. We would then enter 3 for the Halls Order field in the motor dialog box.

Hall Order Numbers for Different Hall Sequences

Halls Order	Hall Sequence
0	1-2-3
1	1-3-2
2	2-1-3
3	2-3-1
4	3-1-2
5	3-2-1



NOTE

Each Hall Voltage is in phase with one and only one Output Voltage.



B leads A for CW

This is the encoder phase relationship for CW/CCW shaft rotation. When you obtain the diagram for your motor phasing similar to shown above, it's assumed by the software that the motor shaft rotates CW when looking at the rear of the motor. For that rotation Encoder phase A must lead phase B. If it does, leave the check box unchecked. Otherwise (if B leads A), check B leads A in the CW box.



NOTE

The reference for direction of rotation is from the rear of the motor.



NOTE

This parameter does not reverse the direction of motor rotation. It is used to setup the motor commutation. See "Rotation Direction" in the Parameters menu to reverse the direction of forward rotation.

5.2.5.3 For Resolver Equipped Motors Only

If parameter "Resolver" is checked, following parameters appear on the form:

Offset in degree (electrical)

This parameter represents offset between resolver's "0 degree" and motor's windings "0 degree".

CW for positive

This parameter sets the direction for positive angle increment.

"Offset in degree" and "CW for positive" will be set during Auto-Phasing of the motor.



Parameters

5.3 Parameters

Lenze AC Tech

Connected | Disconnect | Save Connection | Load Connection | Print | Settings

Motor: E5AP 240V 04 Amp | 192.168.134.1

Parameters

- Communication
 - Ethernet
 - Modbus TCP
 - EtherNet/IP (OP)
 - RS485
 - Modbus RTU
 - CAN
 - CANopen
 - DeviceNet (OP)
 - PROFIBUS-DP
 - IO
 - Digital IO
 - Analog IO
 - Limits
 - Velocity Limits
 - Position Limits
 - Compensation
 - Inverter Program
 - Tools
 - Monitor
 - Faults

Description	Value
Drive Operating Mode	
Drive Mode	Position
Reference	External
Drive PchM Frequency	18 KHZ
Current Limits	
To Change Current Limits	<input type="checkbox"/>
<small>(Warning: Setting the Current Limit or Peak Current Limit at level bigger than the Motor RMS </small>	
Current Limit	4.0000
3 KHZ Peak Current Limit	10.0000
18 KHZ Peak Current Limit	10.0000
Velocity Mode Acceleration	
Enable Accel / Decel Limits	Disable
Accel Limit	1000.0000
Decel Limit	1000.0000
Fault Reset	On Enable
Motor Temperature Sensor	Disable
Motor PTC out-of-Resistance	2500
Regen Duty Cycle	10
Master Encoder Input Type	Master Encoder

Successfully connected to drive : B04090014100000_192.168.134.130

Parameters List - Top

Lenze AC Tech

Connected | Disconnect | Save Connection | Load Connection | Print | Settings

Motor: E5AP 240V 04 Amp | 192.168.134.1

Parameters

- Communication
 - Ethernet
 - Modbus TCP
 - EtherNet/IP (OP)
 - RS485
 - Modbus RTU
 - CAN
 - CANopen
 - DeviceNet (OP)
 - PROFIBUS-DP
 - IO
 - Digital IO
 - Analog IO
 - Limits
 - Velocity Limits
 - Position Limits
 - Compensation
 - Inverter Program
 - Tools
 - Monitor
 - Faults

Current Limit	3.1000
3 KHZ Peak Current Limit	5.2500
18 KHZ Peak Current Limit	5.2500
Velocity Mode Acceleration	
Enable Accel / Decel Limits	Disable
Accel Limit	1000.0000
Decel Limit	1000.0000
Fault Reset	On Disable
Motor Temperature Sensor	Disable
Motor PTC out-of-Resistance	2500
Regen Duty Cycle	10
Master Encoder Input Type	Master Encoder
MASTER ENCODER - Master To System Ratio	
Master	1
System	1
Autoboot	Disable
User Limits	1.0000
Rotational Direction	Normal
<small>(Change applied after power-cycle)</small>	
Resolver Tasks	Track 0 - 1024 PPR

Successfully connected to drive : B04012015100000_192.168.134.130

Parameters List - Bottom



5.3.1 Drive Mode

The PositionServo has 3 operating mode selections: Torque, Velocity and Position.

For Torque and Velocity modes the drive will accept an analog input voltage on the AIN1+ and AIN1- pins of P3 (refer to section 4.3.1). This voltage is used to provide a torque or speed reference.

For Position mode the drive will accept step and direction logic signals or a quadrature pulse train on pins P3.1- P3.4.

5.3.1.1 Torque Mode

In torque mode, the servo control provides a current output proportional to the analog input signal at input AIN1, if parameter “Reference” is set to “External”. Otherwise the reference is taken from the drive’s internal variable. (Refer to the PositionServo Programming Manual for details)

For analog reference “Set Current”, (current the drive will try to provide), is calculated using the following formula:

$$\text{Set Current(A)} = \text{Vinput(Volt)} \times \text{Iscale (A/Volt)}$$

where:

- Vinput is the voltage at analog input
- Iscale is the current scale factor (input sensitivity) set by the Analog input (Current Scale) parameter (section 5.5.4).

5.3.1.2 Velocity Mode

In velocity mode, the servo controller regulates motor shaft speed (velocity) proportional to the analog input voltage at input AIN1, if parameter “Reference” is set to “External”. Otherwise the reference is taken from the drive’s internal variable. Refer to the PositionServo Programming Manual for details.

For analog reference, Target speed (set speed) is calculated using the following formula:

$$\text{Set Velocity (RPM)} = \text{Vinput (Volt)} \times \text{Vscale (RPM/Volt)}$$

where:

- Vinput is the voltage at analog input (AIN1+ and AIN1-)
- Vscale is the velocity scale factor (input sensitivity) set by the Analog input (Velocity scale) parameter (section 5.5.5).

5.3.1.3 Position Mode

In this mode the drive reference is a pulse-train applied to P3.1-4 terminals, if the parameter “Reference” is set to “External”. Otherwise the reference is taken from the drive’s internal motion commands. (Refer to the PositionServo Programming Manual for details).

P3.1-4 inputs can be configured for two types of signals: step and direction and Master encoder quadrature signal. Refer to section 4.2.1 for details on these inputs connections. Refer to section 6.4 for details about positioning and gearing.

When the Reference is set to Internal, the drives reference position, (theoretical or Target position), is generated by trajectory generator. Access to the trajectory generator is provided by motion statements, MOVEx and MDV, from the User Program. Refer to the PositionServo Programming Manual for details.



5.3.2 Reference

The REFERENCE setting selects the reference signal being used by the drive. This reference signal can be either External or Internal. An External Reference can be one of three types, an Analog Input signal, a Step and Direction Input or an Input from an external Master Encoder. The Analog Input reference is used when the drive is either in torque or velocity mode. The Master Encoder and Step and Direction reference is used when the drive is in position mode. An Internal Reference is used when the motion being generated is derived from drive's internal variable(s), i.e., User Program. Refer to the PositionServo Programming Manual.

5.3.3 Drive PWM Frequency

This parameter sets the PWM carrier frequency. Frequency can be changed only when the drive is disabled. Maximum overload current is 300% of the drive rated current when the carrier is set to 8kHz. It is limited to 250% at 16kHz.

5.3.4 Current Limit

The Current Limit setting determines the nominal currents, in amps RMS per phase, that output to the motor phases. To prevent the motor from overloading, this parameter is usually set equal to the motor nominal (or rated) phase current. The Current Limit is set equal to the nominal motor phase current by default when a motor model is selected.

5.3.5 To Change Current Limits

To modify/overwrite the Current Limit place a checkmark in the box. If this box is checked, the parameters "Current limit", "8 kHz peak current limit" and "16 kHz peak current limit" can be overwritten. To prevent the motor from overloading, the "current limit", "8 kHz peak current limit" and "16 kHz peak current limit" shall be set to values no higher than the corresponding current limits of the motor in use.

5.3.6 Peak Current Limit (8 kHz and 16 kHz)

Peak Current Limit sets the motor RMS phase current that is allowed for up to 2 seconds. After this two second limit, the drive output current to motor will be reduced to the value set by the Current Limit parameter. When the motor current drops below nominal current for two seconds, the drive will automatically re-enable the peak current level. This technique allows for high peak torque on demanding fast moves and fast start/stop operations with high regulation bandwidth. If 8 kHz is used for Drive PWM frequency, use the parameter 8 kHz Peak Current Limit, otherwise, use 16 kHz Peak Current Limit.

The Peak Current Limit is set equal to 2.5 times the nominal motor phase current by default when a motor model is selected. The maximum of 3 times nominal motor phase current can be obtained at 8kHz. To prevent motor from overloading, the Peak Current Limit shall be set no higher than the maximum motor current. Otherwise, the motor may be damaged due to overheating. To modify this limit, refer to section 5.3.5.



5.3.7 Accel/Decel Limits (velocity mode only)

The Accel setting determines the time the motor takes to ramp to a higher speed. The Decel setting determines the time the motor takes to ramp to a lower speed. If the Enable Accel/Decel Limits is set to [Disable], the drive will automatically accelerate and decelerate at maximum acceleration limited only by the current limit established by the Peak Current Limit and Current Limit settings. This parameter is only utilized when the drive is set to Velocity mode (refer to 5.3.1).

5.3.8 Fault Reset

Fault Reset selects the type of action required to reset the drive after a FAULT condition has been generated by the drive. On Disable clears the fault when the drive is disabled. This is useful if you have a single drive and motor connected in a single drive system. The On Enable option clears the fault when the drive is re-enabled. Choose On Enable if you have a complex servo system with multiple drives connected to an external controller. This makes troubleshooting easier since the fault will not be reset until the drive is re-enabled. Thus, a technician can more easily determine which component of a complex servo system has caused the fault.

5.3.9 Motor Temperature Sensor

This parameter enables / disables motor over-temperature detection. It must be disabled if the motor PTC sensor is not wired to either P7.1-2 or to the resolver feedback input (P4 or P11).

5.3.10 Motor PTC Cutoff Resistance

This parameter sets the cut-off resistance of the PTC that defines when the motor reaches the maximum allowable temperature. Refer to section 4.5.2 for details on how to connect the motor's PTC.

5.3.11 Regen Duty Cycle

This parameter sets the maximum duty cycle for the brake (regeneration) resistor. This parameter can be used to prevent brake resistor overload. Use the following formula to calculate the maximum value for this parameter. If this parameter is set equal to the calculated value, the regeneration resistor is most effective without overload. One may set this parameter with a value smaller than the calculated one if the drive will not experience over voltage fault during regeneration.

$$D = P * R / (U_{max})^2 * (1/D_{application}) * 100\%$$

Where:

D (%) regeneration duty cycle

U_{max} (VDC) bus voltage at regeneration conditions

U_{max} = 390 VDC for 120/240 VAC drives and 770 VDC for 400/480 VAC drives.

R (Ohm) regeneration resistor value

P (W) regeneration resistor rated power

D_{application} (%) application duty cycle. For the continuous regeneration applications, use D_{application} = 1. For the intermittent regeneration applications, use D_{application} = t/T, where t is the duration when regeneration is needed and T is the time interval between two regenerations. Both t and T must use the same time unit, e.g., seconds



Parameters

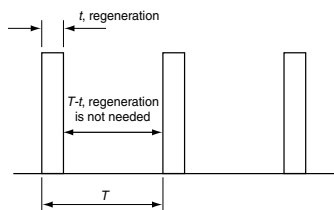

If calculation of D is greater than 100% set it to 100% value. If calculation of D is less than 10% then resistor power rating is too low. For more information refer to the PositionServo Dynamic Braking Manual (G94BR01).

Minimum Required Dynamic Braking Resistance

Drive Model	DB Minimum Resistance (Ω)
E94_180T2N~~	15
E94_080S2F~~, E94_080Y2N~~, E94_100S2F~~, E94_100Y2N~~	20
E94_120Y2N	30
E94_020S1N~~, E94_020S2F~~, E94_020Y2N~~, E94_040S1N~~, E94_040S2F~~, E94_040Y2N~~	40
E94_090T4N~~	45
E94_040T4N~~, E94_050T4N~~, E94_060T4N~~	75
E94_020T4N~~	150

5.3.12 Master Encoder Input Type (position mode only)

This parameter sets the type of input for position reference the drive expects to see. Signal type can be step and direction [Step & Direction] type or quadrature pulse-train [Master Encoder]. Refer to section 4.2.1 for details on these inputs.

5.3.13 Master Encoder - System to Master Ratio

This parameter is used to set the scale between the reference pulse train (when operating in position mode) and the system feedback device. The system feedback device is the motor encoder or resolver.

5.3.14 Autboot

When set to "Enabled" the drive will start to execute the user's program immediately after cold boot (reset). Otherwise the user program has to be started from MotionView or from the Host interface.

5.3.15 User Units

This parameter sets up the relationship between User Units and motor revolutions. From here you can determine how many User Units there is in one motor revolution. This parameter allows the user to scale motion moves to represent a desired unit of measure, (inches, meters, in/sec, meters/sec, etc).

User Units Example: A linear actuator allows a displacement of 2.5" with every revolution of the motor's shaft.

$$\begin{aligned} \text{Units} &= \text{Units} / \text{Revolutions} \\ \text{Units} &= 2.5 \text{ Inches} / \text{Revolution} \\ \text{Units} &= 2.5 \end{aligned}$$



5.3.16 Rotation Direction

This parameter sets up the direction of forward (positive) rotation. To reverse the direction of positive rotation for a specific installation, change Rotation Direction from “Normal” to “Reversed”.

5.3.17 Resolver Tracks

The Resolver Tracks parameter is used in conjunction with the resolver motors and Buffered Encoder Outputs (Section 4.2.2). If a motor with resolver feedback is being used a simulated encoder feedback is transmitted out the Buffered Encoder Outputs, P3.7 to P3.12. The default resolution of this feedback is 1024 pulses per revolution, pre quad. If a different resolution is required then the Resolver Tracks parameter is utilized. The number entered into this field, 0-15, correlates to a specific encoder resolution.

Resolver Tracks Configuration

Resolver Track	Resolution Before Quad	Resolver Track	Resolution Before Quad
0	1024	8	1000
1	256	9	1024
2	360	10	2000
3	400	11	2048
4	500	12	2500
5	512	13	2880
6	720	14	250
7	800	15	4096



5.4 Communication

The Communication folder contains four sub-folders: Ethernet, RS-485, CAN and PROFIBUS plus sub-sub folders to program the parameters specific to the communication type. Select the Fieldbus used from the pull-down menu (None, CANOpen Simple 301, DeviceNet or PROFIBUS).



NOTE

Ethernet is always enabled regardless of the fieldbus selected. Gatewaying is not supported between fieldbus and Ethernet.

5.4.1 Ethernet

Refer to section 6.2 on setting an IP address. The Ethernet folder displays the IP Address, Subnet Mask and Default Gateway for the drive selected in the Node Tree. The TCP Reply Delay can be set in 1 millisecond increments from 0 to 15ms. To obtain the IP address via DHCP, check the box adjacent to [Obtain IP address using DHCP].

The Ethernet folder contains the sub-folders: Modbus TCP and EtherNet/IP. Defined by the Ethernet hardware settings, no further settings are necessary to communicate via Modbus TCP. Also defined by the Ethernet hardware settings, the EtherNet/IP folder contains the configuration parameters for the EtherNet/IP (Industrial Protocol). In general, there is no need to change parameters for multicast operations. Consult your IT administrator for these settings as their configuration is very network-specific.

5.4.2 RS-485

To configure the RS485 interface, option module E94ZARS41, set the following parameters: RS485 Configuration, RS485 Baud Rate, RS485 Parity, RS485 Stop Bits and RS485 Address. The RS485 interface can be configured for UPPP operation or as a Modbus RTU slave.

The RS-485 folder contains one sub-folder: Modbus RTU. The Modbus RTU folder contains the Modbus Reply Delay parameter which sets the time delay between the drive's reply to the Modbus RTU master. This delay is needed for some types of Modbus masters to function correctly.

5.4.3 CAN

The CAN baud rate and CAN address are set in the main CAN folder. The main CAN folder contains two sub-folders: CANOpen and DeviceNet. In the CANOpen sub-folder, the CAN Bootup Mode, CAN Bootup Delay and CAN Heart Beat Time parameters are set. Mapping of the CAN process data objects (PDO) is also carried out from this folder. In the DeviceNet folder, the DeviceNet Poll I/O Scaling parameter is set.

5.4.4 PROFIBUS

These parameters are set in the PROFIBUS folder: PROFIBUS Address, Acyclic Mode, Data Exchange Timeout plus the IN/OUT Data Size, Parameter ID Number and Mapping Type.



5.5 Analog I/O

5.5.1 Analog Output

The PositionServo has one analog output with 10-bit resolution on P3 pin 23. The signal is scaled to $\pm 10V$. The analog output can be assigned to the following functions:

- Not Assigned
- Phase current RMS
- Phase current Peak
- Motor Velocity
- Phase R current
- Phase S current
- Phase T current
- Iq current (Torque component)
- Id current (Direct component)

5.5.2 Analog Output Current Scale (Volt/Amps)

Applies scaling to all functions representing CURRENT values.

5.5.3 Analog Output Velocity Scale (mV/RPM)

Applies scaling to all functions representing VELOCITY values. (Note: that mV/RPM scaling units are numerically equivalent to volts/kRPM)

5.5.4 Analog Input Current Scale (Amps/Volt)

This parameter sets the analog input sensitivity for current reference used when the drive operates in torque mode. Units for this parameter are A/Volt. To calculate this value use the following formula:

$$I_{scale} = I_{max} / V_{in\ max}$$

I_{max} maximum desired output current (motor phase current RMS)
 $V_{in\ max}$ max voltage fed to analog input at I_{max}

Example:

$$\begin{aligned} I_{max} &= 5A \text{ (phase RMS)} \\ V_{in\ max} &= 10V \\ I_{scale} &= I_{max} / V_{in\ max} \\ &= 5A / 10V = 0.5 \text{ A / Volt (value to enter)} \end{aligned}$$

5.5.5 Analog Input Velocity Scale (RPM/Volt)

This parameter sets the analog input sensitivity for the velocity reference used when the drive operates in velocity mode. Units for this parameter are RPM/Volt. To calculate this value use the following formula:

$$V_{scale} = VELOCITY_{max} / V_{in\ max}$$

$VELOCITY_{max}$ maximum desired velocity in RPM
 $V_{in\ max}$ max voltage fed to analog input at $Velocity_{max}$

Example:

$$\begin{aligned} VELOCITY_{max} &= 2000 \text{ RPM} \\ V_{in\ max} &= 10V \\ V_{scale} &= VELOCITY_{max} / V_{in\ max} \\ &= 2000 / 10V \\ &= 200 \text{ RPM / Volt (value to enter)} \end{aligned}$$



5.5.6 Analog Input Dead Band

Allows the setting of a voltage window (in mV) at the reference input AIN1+ and AIN1- (P3 pins 24 and 25) such that any voltage within that window will be treated as zero volts. This is useful if the analog input voltage drifts resulting in motor rotation when commanded to zero.

5.5.7 Analog Input Offset

This function allows the drive to automatically adjust the analog input voltage offset. To use it, command the external reference source input at AIN1+ and AIN1- (P3 pins 24 and 25) to zero volts and then click the [<<] button adjacent to the [Analog Input Offset] box. Any offset voltage at the analog input will be adjusted out and the adjustment value will be stored in the [Analog input offset] parameter.

5.6 Digital I/O

5.6.1 Digital Output

The PositionServo has four programmable digital outputs. These outputs can be assigned to one of the following functions, or used by the drive's internal User Program.

Not Assigned	No function assigned. Output can be used by the User program.
Zero Speed	Output activated when drive is at zero speed, refer to "Velocity Limits Group" (section 5.7) for settings.
In Speed Window	Output activated when drive is in set speed window, refer to "Velocity Limits Group" (section 5.7) for settings.
Current Limit	Output activated when drive detects current limit.
Run Time Fault	A fault has occurred. Refer to section 7.3 for details on faults.
Ready	Drive is enabled.
Brake	Output is active for the time programmed by the Brake Release Delay parameter after the drive is enabled and deactivates after the drive is disabled for control of a motor mechanical brake.
In position	Position mode only. Refer to the PS Programming Manual.

5.6.2 Digital Input De-bounce Time

Sets de-bounce time for the digital inputs to compensate for bouncing of the switch or relay contacts. This is the time following an input transition when any further transitions will be ignored (not recognized by the drive).

5.6.3 Hard Limit Switch Action

Digital inputs IN_A1 and IN_A2 can be used as limit switches if their function is set to "Fault" or "Stop and Fault". Activation of these inputs while the drive is enabled will cause the drive to Disable and go to a Fault state. The "Stop and Fault" action is available only in Position mode when the "Reference" parameter is set to "Internal", i.e., when the source for the motion is the Trajectory generator. Refer to the PositionServo Programming Manual for details on "Stop and Fault" behavior.

5.6.4 Enable Switch Function

The Enable input (IN_A3) on PositionServo can be set to function as either a 'Run' Input or an 'Inhibit' Input. The run function allows input A3 control of switching the drive between enable and disable states (Enabling or disabling output to the motor). The Run function is typically used in centralized systems where a PLC or Motion Control output is required to control the enable/disable of the drive.



When input A3 becomes active the drive will go immediately to an enable state, and when it becomes inactive the drive will go immediately to a disabled state.

The inhibit function allows input A3 to inhibit (prevent) power being applied to the motor but does not provide the enable or disable command for the drive. This function is typically used in a centralized system where the drive's internal programming determines when the drive should enable or disable (these statements are executed within the drive programming). In the inhibit mode Input A3 acts as a hardware level inhibit, only allowing the drive to go to an enable state (when instructed from the internal programming) providing the input A3 is active. Attempting to enable from the internal user program while input A3 is inactive will cause the drive to trip (Fault F_36) as will removal of input A3 while the drive is in an enabled state.

Input A3 cannot be bypassed, it must be present to obtain any power to the motor or motion.

5.6.5 Brake Release Delay

The Brake Release Delay controls the amount of time an output configured as "brake" waits after the drive enables to activate the brake output. The range for Brake Release Delay is 0-2000 milliseconds and the default value is 0ms.

5.7 Velocity Limits

In the Velocity Limits folder are 3 programmable parameters: Zero Speed, Speed Window and At Speed. These parameters are active in Velocity Mode Only.

5.7.1 Zero Speed

Specifies the upper threshold for motor zero speed in RPM. When the motor shaft speed is at or below the specified value, the zero speed condition is set to true in the internal controller logic. The zero speed condition can also trigger a programmable digital output, if selected. The Zero Speed range is 0 to 100 RPM and the default value is 10 RPM.

5.7.2 Speed Window

Speed Window specifies the width used with the "In speed window" output. The Speed Window range is 10 to 10,000 RPM and the default value is 100 RPM.

5.7.3 At Speed

At Speed specifies the speed window center used with the "In speed window" output. The At Speed range is -10000 to 10000 RPM and the default value is 1000 RPM.

Speed Window and At Speed specify speed limits. If motor shaft speed is within these limits then the condition AT SPEED is set to TRUE in the internal controller logic. The AT SPEED condition can also trigger a programmable digital output, if selected.

For example if "AT SPEED" is set for 1000 RPM, and the "SPEED WINDOW" is set for 100, then "AT SPEED" will be true when the motor velocity is between 950 -1050 RPM.



5.8 Position Limits

5.8.1 Position Error

Specifies the maximum allowable position error in the primary (motor mounted) feedback device before enabling the “Max error time” clock. When using an encoder, the position error is in post-quadrature encoder counts. When using a resolver, position error is measured at a fixed resolution of 65,536 counts per motor revolution.



STOP!

If Position Error is set to 0, position error checking is disabled. Carefully evaluate the application for safety aspects before disabling position error checking.

5.8.2 Max Error Time

Specifies maximum allowable time (in mS) during which a position error can exceed the value set for the “Position error” parameter before a Position Error Excess fault is generated. If the Position Error is set to the max setting then the drive will trip and not use the Error time when the error exceeds the above setting.

5.8.3 Soft Limits

Enables/disables the usage of a software defined limit. Do not enable this feature until after the drive is homed for the specific application. Like all parameters, this setting can be set/reset logically within the Indexer program.

Positive Limit Soft limit switch location in User Units

Negative Limit Soft limit switch location in User Units

5.9 Compensation

5.9.1 Velocity P-gain (proportional)

Proportional gain adjusts the system’s overall response to a velocity error. The velocity error is the difference between the commanded velocity of a motor shaft and the actual shaft velocity as measured by the primary feedback device. By adjusting the proportional gain, the bandwidth of the drive is more closely matched to the bandwidth of the control signal, ensuring more precise response of the servo loop to the input signal.

5.9.2 Velocity I-gain (integral)

The output of the velocity integral gain compensator is proportional to the accumulative error over cycle time, with I-gain controlling how fast the error accumulates. Integral gain also increases the overall loop gain at the lower frequencies, minimizing total error. Thus, its greatest effect is on a system running at low speed, or in a steady state without rapid or frequent changes in velocity.



NOTE

The following 4 position gain settings are only active if the drive is operating in Position mode. They have no effect in Velocity or Torque modes.



5.9.3 Position P-gain (proportional)

Position P-gain adjusts the system's overall response to position error. Position error is the difference between the commanded position of the motor shaft and the actual shaft position. By adjusting the proportional gain, the bandwidth of the drive is more closely matched to the bandwidth of the control signal, ensuring more precise response of the servo loop to the input signal.

5.9.4 Position I-gain (integral)

The output of the Position I-gain compensator is proportional to accumulative error over cycle time, with I-gain controlling how fast the error accumulates. Integral gain also increases overall loop gain at the lower frequencies, minimizing total error. Thus, its greatest effect is on a system running at low speed, or in a steady state without rapid or frequent changes in position.

5.9.5 Position D-gain (differential)

The output of the Position D-gain compensator is proportional to the difference between the current position error and the position error measured in the previous servo cycle. D-gain decreases the bandwidth and increases the overall system stability. It is responsible for removing oscillations caused by load inertia.

5.9.6 Position I-limit

The Position I-limit will clamp the Position I-gain compensator to prevent excessive torque overshooting caused by an over accumulation of the I-gain. It is defined in terms of RPM. This is especially helpful when position error is integrated over a long period of time.

5.9.7 Gain Scaling Window

Sets the total velocity loop gain multiplier ($2n$) where n is the velocity regulation window. If, during motor tuning, the velocity gains become too small or too large, this parameter is used to adjust loop sensitivity. If the velocity gains are too small, decrease the total loop gain value, by decreasing this parameter. If gains are at their maximum setting and you need to increase them even more, use a larger value for this parameter.

5.9.8 Disable High Performance Mode

If the box is checked, the drive uses the gain modeling algorithm from hardware revision 1 of the PositionServo. This setting is enabled by default to facilitate the replacement of legacy platform 940/941 (hardware revision 1) installations without re-tuning. This setting should be de-selected for best results with Auto Tuning.

5.9.9 Auto Tuning

Click the [Autotuning] button to access the Auto Tuning parameter. this parameter auto tunes the compensation gains for the motor/load applied.



NOTE

For best results, de-select [Disable High Performance Mode] prior to auto tuning.



5.9.10 Set Default Gains

Click the [Set Default Gains] button to access the Default Gains parameter. Selecting [Set Default Gains] will reset the gains to the default values in the motor file.

5.9.11 Feedback and Loop Filters

Hardware Version 2 provides for the use of 1 feedback filter and 2 cascaded loop filters. Loop filters are identical in structure and operation.

The feedback filter is a low-pass first order filter used primarily to filter noise from the feedback device. The time constant of the filter is settable and from 2mS and up. Values of 2 – 8mS are generally adequate for most applications.

The Loop filter can be configured as a Low-Pass, Notch or Resonant type filter.

The Low pass filter is used to lower noise in the system produced by control and feedback signal disturbances and quantization noise. The Low-pass cut off frequency is usually set at 5-10 times the desired velocity loop bandwidth.

If enabled, the loop filter is installed between the velocity and current loop.

The Loop filter can be configured as a Notch or Resonant type filter. Both configurations implement band-stop filtering for solving certain mechanical compliance problems. A common problem is torsional resonance due to mechanical compliance between load inertia and motor inertia. Consider a motor coupled with a long load shaft with an inert load at the opposite end. Such a system will have a resonant frequency of

$$f_r = \frac{1}{2\pi} \sqrt{\frac{K_s}{J_p}} \quad [\text{Hz}]$$

where

JL = load inertia [kgm²]

JM = motor inertia [kgm²]

Ks = total stiffness of coupling and shaft [Nm/rad]

Jp = (JL * JM) / (JL + JM)

π = 3.1416

Applying the loop filter at this frequency in the configuration “Resonant Filter” will cancel the resonant pole effectively allowing higher overall loop gain without losing stability.

The Resonant filter setting allows the user to set the resonant frequency, the bandwidth of the filter as well as maximum attenuation gain in dB.

The Notch filter serves a similar purpose as the resonant filter. It has programmable bandwidth and center frequency. The Gain in the center frequency point is not programmable and depends on the bandwidth of the filter which is programmable. The resonant filter is a second order bi-quad filter with -20dB/dec roll-off.

This resonant filter is good for applications where resonances have a wide bandwidth rather than in those that have a big amplitude and narrow bandwidth.



5.10 Tools

The [Tools] folder contains two action buttons: Oscilloscope and Parameter I/O View. These tools allow the user to perform real-time diagnostics.

5.10.1 Oscilloscope

The Oscilloscope tool provides a real-time display of the different electrical signals inside the PositionServo drive. The signals in the following table can be observed on the two channels of the Oscilloscope tool. Click on the [Oscilloscope] tool to open the Oscilloscope in a separate window.

Oscilloscope Parameters

Signal	Description
Phase Current RMS	Motor phase (RMS) current
Phase Current Peak	Motor phase peak current
Iq Current	Motor Iq (torque producing) current
Motor Velocity	Actual motor speed in RPM
Command Velocity	Desired motor speed in RPM (Velocity mode only)
Velocity Error	Difference in RPM between actual and commanded motor speed
Position Error	Difference between actual and commanded position (Step & Direction mode only)
Bus Voltage	DC bus voltage
Analog Input	Voltage at the drive's analog input AIN1
Target Position	Requested position
Target Position Pulses	Requested position expressed in pulses of the primary feedback device
Absolute Position	Absolute position (actual position)
Absolute Position Pulses	Absolute position expressed in pulses of the primary feedback device
Position Increment	Commanded position increment

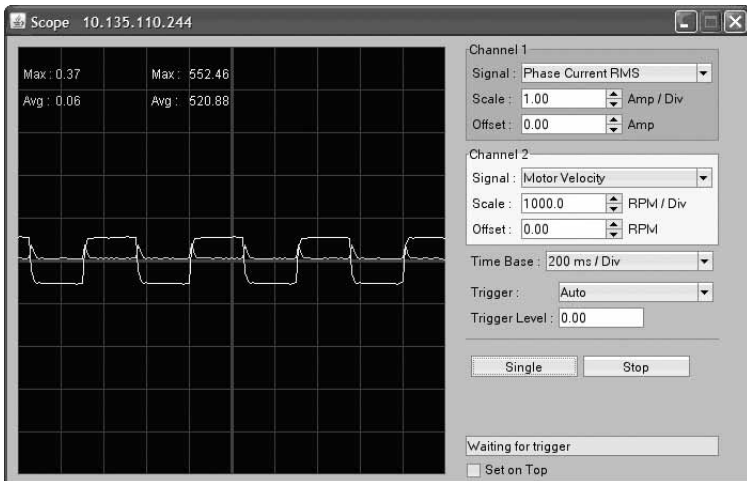

Oscilloscope Display



Parameters

Signal Name

The user can customize the information presented on the Scope tool by choosing the drop-down box in each channel. The set of available signals depends on the drive mode. Refer to the Oscilloscope Parameters table for the list of the signals.

Scale

Scale sets the sensitivity of the display. Each division is considered one unit of the selected scale. A scale of 100 RPM/div, for example, means that the signal will rise (or descend) by one vertical division for every change of 100 RPM in the signal level. Thus, a 500-RPM signal would deflect the signal by five vertical divisions from the central reference line.

Offset

Offset sets the vertical distance from the central base line to the signal trace. This is useful if you want to compare two signals. For example, if you wish to compare the actual vs. commanded motor velocity, you would enter an offset that would move the two signals to alternate sides of the central reference line.

Time Base

Time base sets the number of milliseconds displayed per horizontal division. Higher frequencies have a shorter time base than lower frequencies. If you wanted to display one cycle of a particular signal, your time base setting would therefore be lower for high-frequency signals than for low-frequency signals.

Trigger/Trigger Level

Trigger level specifies the signal level after which the scope starts acquiring data. You can also specify which channel will be a source for the trigger. The oscilloscope display will continue to run while the signal level crosses the specified level (above if the trigger is set for rising or leading edge, or below if the trigger is set for falling or trailing edge).

Single

Also called one-shot trigger. If Single Sweep is selected, data acquisition will be stopped after the scope buffer is filled and data displayed on the screen (frozen data). To repeat data acquisition, you will need to click the **Single** again.

Run / Stop

Select [Run] for a continuous trigger. Select [Stop] to disable the trigger.

Set on Top

Select this button to display the oscilloscope window on top of all other windows.

5.10.2 Parameter & I/O View

The [Parameter & IO View] tool permits the user to access the list of variables. Click on the [Parameter & IO View] button to open the diagnostic tool in a separate window. Click on the box adjacent to [Set on Top] to keep this window on top. Also known as the Debug Tool, the Parameter and I/O View permits the user to view the values of the drive's variables plus the I/O status.

To add a variable to the View List, click on [Add] then browse to [Variable Name] in the pop-up window, then click on the left arrow button. To remove a variable from this View List, click on the variable name in the View list and then click on the right arrow button. To save the variable list, click [Save]. To load the variable list, click [Load].



To edit a parameter's value, double click the [Decimal] field of the parameter. When the text is double-clicked, the background color will change. The parameter value will stop updating allowing you to change the value. However, if the interface device or user's program manipulates the value of the parameter, then your change will be overwritten in a concurrent manner.

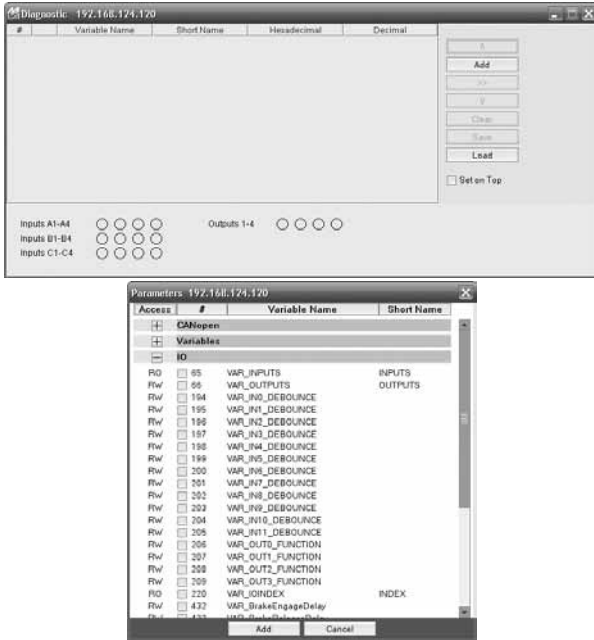

Parameter I/O View with Variables



NOTE

By clicking [#], the variables can be automatically sorted in descending or ascending order. They can also be sorted alphabetically by clicking [Variable Name] and/or [Short Name].



NOTE

Write-only variables may not contain valid data in the "Parameter and I/O" view screen as all write-only variables in the drive use a common display buffer.

5.11 Faults

The [Faults] folder contains three action buttons upon opening and displays the most recent fault. [Load Faults] permits the user to load the entire stored fault history of the drive onto the computer. The sixteen most recent faults are displayed with the newer faults replacing the older faults in a first-in, first-out manner. In all cases, the fault on top of the list is the most recent fault. [Clear Faults] clears the fault history of the drive from within the MotionView program. The device time of the fault is the time from last power up (Power-up time = 00:00). Each fault has its code and explanation of the fault. Refer to section 8.4 for details on faults. [Clear Fault/Reset] clears the active fault and resets the drive.



Parameters



NOTE

The [Clear Faults] operation will disrupt motion and the program being executed. It is recommended not to clear faults while running an application.

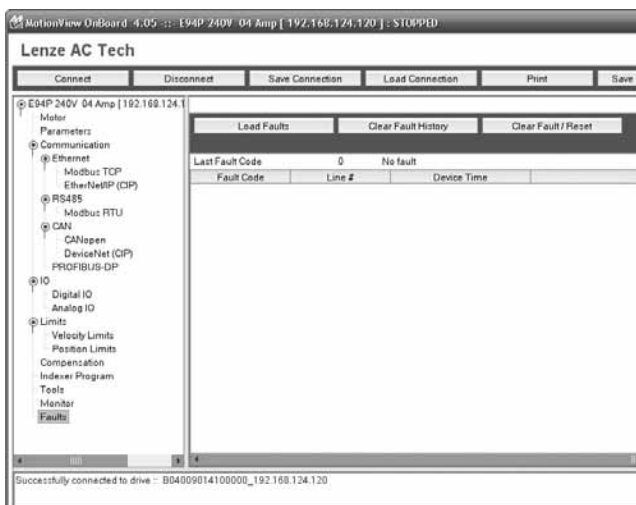

5.12 Monitor

The Monitor window displays common diagnostic information for the drive's status. Click the [Set on Top] box to keep the Monitor displayed while manipulating other screens in MotionView.

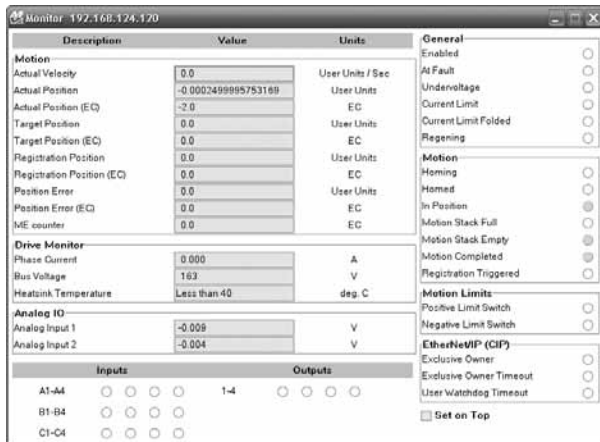



6 Operation

This section offers guidance on configuring the PositionServo drive for operations in torque, velocity or position modes without requiring a user program. To use advanced programming features of PositionServo please perform all steps below and then refer to the PositionServo Programming Manual for details on how to write motion programs.

6.1 Minimum Connections

For the most basic operation, connect the PositionServo to mains (line) power at terminal P1, the servomotor power at P7 and the motor feedback as appropriate.



DANGER!

Hazard of electrical shock! Circuit potentials are up to 480 VAC above earth ground. Avoid direct contact with the printed circuit board or with circuit elements to prevent the risk of serious injury or fatality. Disconnect incoming power and wait at least 60 seconds before servicing drive. Capacitors retain charge after power is removed.

As a minimum these connections must be made:

- Connect an Ethernet crossover cable between PositionServo's P2 and your PC's Ethernet port. A straight patch cable can be used if using a hub or switch.
- Connect mains power to terminal P1. Mains power must be as defined on the drive's data label (Refer to label in 'About These Instructions' section).
- When connecting to an encoder-based drive, take the encoder feedback cable and connect it to the 15 pin D-sub connector located at P4. When connecting to a resolver-based drive, take the resolver feedback cable and connect it to the 9 pin D-sub connector located at P4.
- Connect motor windings U, V, W (a.k.a. R, S, T) to terminal P7 as shown in section 4.1.1. Make sure the motor cable shield is connected as in section 3.2.
- Provide an Enable switch according to Section 6.6.
- Perform drive configuration as described in the next section.



NOTE

To run MotionView OnBoard on a Mac OS, run the PC emulation tool first.



NOTE

The recommended screen setting size for the PC is 1680 x 1050.

6.2 Ethernet Connection

Configuration, Programming and diagnostics of the PositionServo drive are typically performed over the standard 10/100 Mbps Ethernet communication port using the 'MotionView OnBoard' software contained within the drive itself.

To access the MotionView OnBoard software and configure the drive the PositionServo drive and PC must be configured to operate on the same Ethernet network. The IP addresses of the PositionServo drive, the PC, or both drive and PC may be required to be configured to enable Ethernet communications between the two devices.



NOTE

Any changes made to the Ethernet communication settings on the PositionServo do not take effect until the drive is powered off and powered on again. Until this time the drive will continue to use its previous settings.



NOTE

For any PC that will need regular configuration to communicate with a PositionServo Drive and if the default PC Ethernet port on your computer is already being used for another purpose (such as email, web browsing, etc.) then it may be more convenient for the operator to add an additional Ethernet port to the PC.

The most common and cost effective way to do this is by using a USB / Ethernet dongle or a PCMCIA Ethernet card. The additional port can be configured for communication to the PositionServo drive without effecting the operation of other PC functions.

6.2.1 PositionServo Ethernet Port Configuration

The IP address of the PositionServo drive is composed of four sub-octets that are separated by three dots to conform to the Class C Subnet structure. Each sub-octet can be configured with number between 1 and 254. As shipped from the factory the default IP address of a drive is:

192.168.124.120.

There are two methods of changing the current IP address. An address can be assigned to the drive automatically (dynamic IP address) when the drive is connected to a DHCP (Dynamic Host Configuration Protocol) enabled server, or the drive can have an IP address assigned to it manually by the user (static IP address). Both methods of configuring the drive's IP address are detailed herein.

6.2.1.1 Obtaining the PositionServo's Current Ethernet Settings

The current Ethernet setting and IP address of the PositionServo drive can be obtained from the drive display and keypad. Press the recessed 'mode' button (↵) on the display and use the "UP" and "DOWN" buttons (▲ ▼) to access parameters IP_1, IP_2, IP_3 and IP_4. Each of these parameters contain one sub-octet of the full IP address, for example in the case of the drive default (factory set) address parameters:

IP_1 = 192
IP_2 = 168
IP_3 = 124
IP_4 = 120

By accessing these four parameters the full IP address on the drive can be obtained.

If parameters IP_1, IP_2, IP_3 and IP_4 all contain '----' rather than a numerical values it means that the drive has DHCP enabled and the DHCP server is yet to assign the drive its dynamic IP address. As soon as an IP address is assigned by the server the address assigned will be display by the drive in the above parameters. See section on obtaining IP addresses through DHCP.

6.2.1.2 Configuring the IP Address Manually (Static Address)

When connecting directly from PositionServo drive to the PC without a server or when connecting to a private network (where all devices have static IP addresses) the IP address of the PositionServo drive will need to be assigned manually.

To assign the address manually, the drive must have its DHCP mode disabled. This can be done using the drive keypad and display. Press the recessed 'mode' button (↵) on the display and use the "UP" and "DOWN" buttons (▲ ▼) to access parameter 'DHCP'. Check this parameter is set to a value of '0'. If the DHCP parameter is set to '1' then use the 'mode' (↵) and down (▼) arrows to set to '0' and then cycle power to the drive in order for this change to take effect. When DHCP is disabled and power cycled to the drive, it will revert back to its previous static IP address.



It is most common for the PositionServo drive IP address to be left at its default value (192.168.124.120) and to configure the PC Ethernet port to communicate on this subnet. If more than one drive needs to be connected to the PC at any one time then the IP_4 parameter can be accessed via the keypad and changed to provide a unique IP address on the network for each drive. Note that IP_4 is the only octet that can be changed (IP_1, IP_2, and IP_3 are read-only) and that power must be cycled to the drive for any changes to take effect.

If the PositionServo drive(s) needs to be configured for a specific subnet with different values to default (for IP_1, IP_2, and IP_3, and IP_4) then this needs to be performed with the MotionView configuration tool. First establish communications using the default drive address or with an address that was established by changing IP_4 parameters via the drive keypad. Follow the rest of these instructions in order to establish communications and launch MotionView using this address. Once within the MotionView software a full IP address can be assigned.

From the Node tree within MotionView select the [Communications] folder and then the [Ethernet] sub-folder as shown herein. The settings reflect those that will appear in the software parameter view window.



The IP address, subnet mask, and default gateway address can all be edited in this screen. If the text in any of these boxes turns red once it has been entered then this means that the values or format used is invalid and the values will not be applied.

To enable DHCP, click the box adjacent to [Obtain IP Address using DHCP] to place a check mark in this box . To disable DHCP, click the box again. Power must be cycled for any changes to [Configure IP Address] to take effect. On changing any ethernet parameter value, the following dialog box will appear. Click [Ok] and cycle power for changes to take effect.

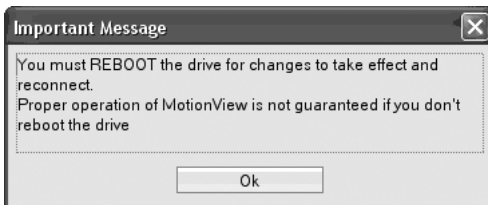



Operation

6.2.1.3 Configuring the IP Address Automatically (Dynamic Address)

When connecting a PositionServo drive onto a network domain with a DHCP enabled server (where all devices have dynamic IP addresses assigned by the server) the IP address of the PositionServo drive can also be assigned automatically by the server.

To have the address assigned automatically the drive must have its DHCP mode enabled. This can be done by using the drive keypad and display. Press the 'mode' button on the display and use the "UP" and "DOWN" buttons to access parameter 'DHCP'. Check this parameter is set to a value of '1'. If the DHCP parameter is set to '0' then use the 'mode' and up arrow to set to '1' and then cycle power to the drive in order for this change to take effect.

When the PositionServo drive is waiting for an IP address to be assigned to it by the server it will display '----' in each of the four octet parameters (IP_1, IP_2, IP_3, and IP_4) on its display. Once the address is assigned by the server it will appear in these parameters. If this parameters continue to display '----' then it is likely that a connection between the drive and server has not been established, or the server is not DHCP enabled.

DHCP can be enabled through the MotionView software for convenience should the operator wish to configure the drive using a manual (static) IP address and switch over to an automatic (dynamic) address once configuration is complete. See section 6.2.1.1 for information on enabling DHCP from within the MotionView software.



NOTE

A useful feature of the MotionView software and communications interface to the PositionServo drive is the ability to assign the drive a name (text string). This name can then be used to discover the drive's IP address and is useful when the drive has its IP address assigned automatically by the server for easy connection. Refer to section on MotionView connection window, below.

6.2.2 Configuring the PC IP Address (Windows XP)



NOTE

This section of the manual gives some guidance on how to configure the Ethernet communications setting on a PC to communicate with a PositionServo drive. Additional material for other operating systems/platforms may be available from the website or as an appendix to existing drive documentation. If the drive and PC are both assigned automatic IP addresses from a DHCP enabled server then configuration of the PC port should not be necessary.

The following is a step by step guide to configure the PC IP address in Windows XP using either the classic or category viewing mode.

To access the network settings on a Windows XP based PC:

Category (Default) View:

[Start]
[Control Panel]
[Network & Internet Connections]
[Network Connections]

Classic View:

[Start]
[Settings]
[Control Panel]
[Network Connections]



Operation

Regardless of the Windows XP viewing mode the following [Network Connections] screen will appear. Hereafter all configuration screens are the same regardless of selected Windows XP viewing mode.



Select the connection you wish configure. [Local Area Connection] is typically the standard or local Ethernet port on the PC (the port supplied with the PC), with any additional hardware ports displayed as [Local Area Connection x] (with x being a numerical value). Double-click the icon for the port you wish to configure. The [Local Area Connection Properties] screen will appear.

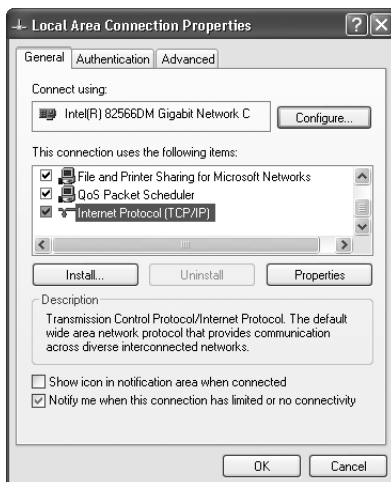

Use the vertical scroll bar on the right hand side of the screen to scroll down to the [Internet Protocol (TCP/IP)] option in the selection window. Select this option and click the [Properties] button. The [Internet Protocol (TCP/IP) Properties] screen will appear.



Select [Use the following IP address]. The IP address and Subnet mask text boxes can now be edited.

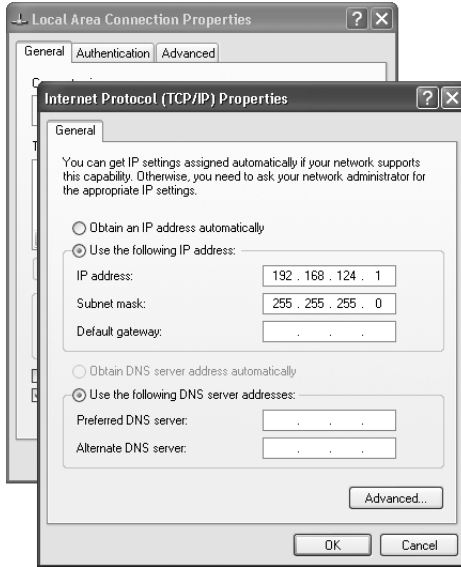

Enter an IP address for the PC. This IP address will need to be unique to the PC (different to any other device on the network) but still allow communication on the same subnet that the drive is set to. To set up the PC IP address in this way enter the first three values of the IP address box to be identical to those set in IP_1, IP_2, and IP_3 parameters on the PositionServo drive. For the last value (IP_4) pick a unique value different to any other device on that network.

If the drive IP address has been left at its factory (default) value then a logical IP address to assign to the PC might be 192.168.124.1

When exiting the IP address box the value in the subnet mask text box should default to 255.255.255.0. This value tells the PC that all other devices on the network share the same values for the first 3 Octets of their IP addresses with the last octet beginning unique to those devices. Typically the default value can be left unchanged unless a larger network needs to be specified.



NOTE

If the PC and drive need to obtain an IP address from a DHCP enabled server then the [Obtain an IP address automatically] option should remain ticked and no values should be present for either the IP address or subnet mask.

6.2.3 Initial Connection to the Drive

Before connecting to the PositionServo drive and attempting to run the MotionView software check the PC has the following features installed:

- Java Run Time Environment 1.4 or higher
(download latest version at <http://www.java.com>)
- Web Browser (Internet Explorer, Mozilla Firefox, Netscape, etc)



Operation

Physically connect the Drive to the PC:

To connect directly between a PC and a PositionServo drive it is recommended that a CAT 5e crossover cable be connected between the P2 port on the PositionServo drive and the Ethernet port on the PC.

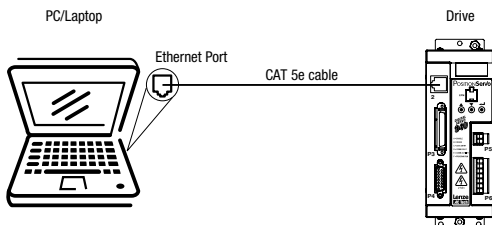

To Connect from a PC to a PositionServo drive via an Ethernet switch or hub it is recommended that a CAT 5e straight through cable be connected from both the drive and PC directly to the Hub or switch.

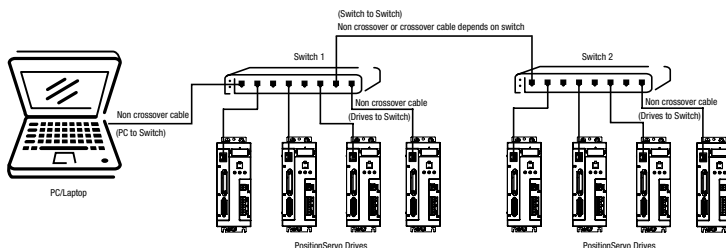

6.2.4 Launching MotionView & Communicating to the PS Drive

Open your PC's web browser.

Enter the drive's default IP address [192.168.124.120] in the browser's Address window.



The authentication screen may be displayed if the PC does not have Java RTE version 1.4 or higher. To remedy this situation, download the latest Java RTE from <http://www.java.com>.



Java Authentication



Java Splash Screen



When MotionView has finished installing, a Java icon entitled [MotionView OnBoard] will appear on your desktop and the MVOB splash screen is displayed. Click [Run] to enter the MotionView program.



MotionView OnBoard Splash Screen

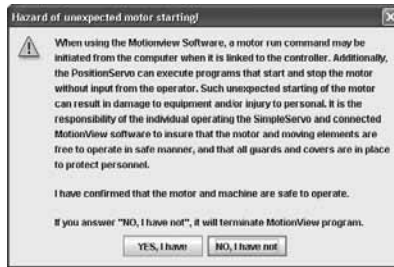

WARNING Statement on Initial MotionView Display

Once MotionView has launched, verify motor is safe to operate, click [YES, I have] then select [Connect] from the Main toolbar (top left).

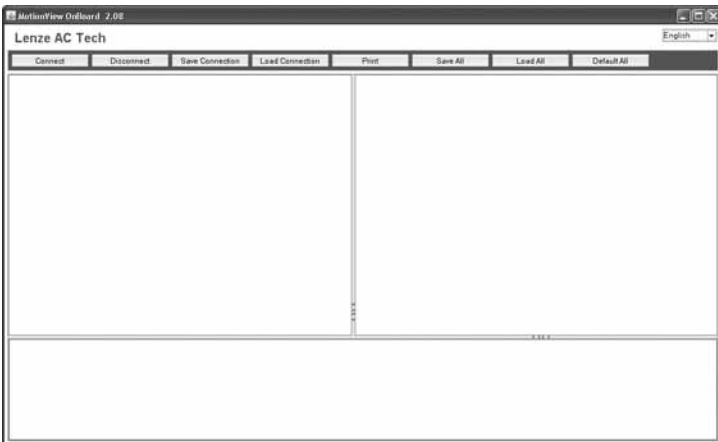

Initial MotionView Display



Operation

The Connection dialog box will appear.

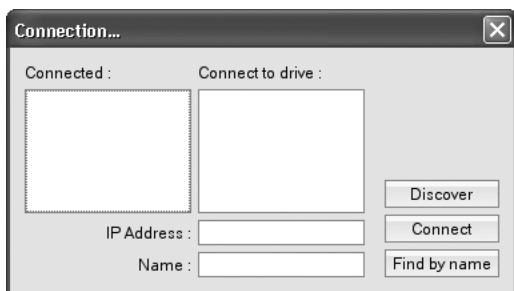

Connection Dialog Box

Select [Discover] to find the drive(s) on the network available for connection.



NOTE

[Discover] may fail to find the drive's IP address on a computer with both a wireless network card and a wired network card. If this happens, try one of these remedies:

- Disable the wireless network card and then use [Discover].
 - Type in the drive's IP address manually at the box [IP Address].
- Then click [Connect].

Highlight the drive (or drives) to be connected and click [Connect] in the dialog box.

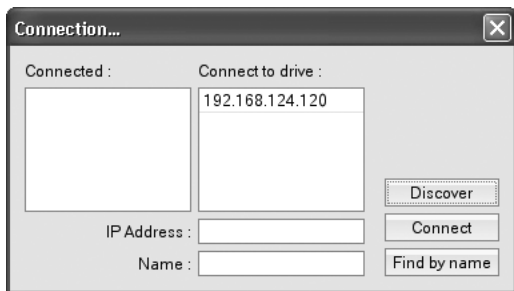

Connection Box with Discovered Drive

In the lower left of the MotionView display, the Message Window will contain the connection status message. The message "Successfully connected to drive B04402200450_192.168.124.120" indicates that the drive B04402200450 with IP address 192.168.124.120 is connected.

Sequentially connecting 2 Ethernet-based Drives

If when trying to sequentially commission several Ethernet-based drives with the same PC, MotionView discovers the IP address, but then reports that the drive cannot be connected; open the Command window on your PC and run the command "arp -d" just before connecting MotionView to another drive.

ARP is the Address Resolution Protocol. Each PositionServo drive has two addresses, one MAC address and one IP address. ARP links these two addresses together. Each PositionServo drive has the same factory default IP address, but a different MAC address. After connecting the first drive, the Ethernet hub will cache its IP and MAC address for about 2 minutes. When another drive with the same IP address and different MAC address is connected to the network, ARP will observe the mismatching between the IP address and MAC address.



6.3 Parameter Storage and EPM Operation

6.3.1 Parameter Storage

All settable parameters are stored in the drive's internal non-volatile memory. Parameters are saved automatically when they are changed. In addition, parameters are copied to the EPM memory module located on the drive's front panel. In the unlikely event of drive failure, the EPM can be removed and inserted into the replacement drive, thus making an exact copy of the drive being replaced. This shortens down time by eliminating the configuration procedure. The EPM can also be used for replication of the drive's settings.

6.3.2 EPM Operation

When the drive is powered up, a comparison is made between the drive's internal memory and the EPM. If a correctly formatted EPM is inserted, the EPM will over-ride the internal memory with the settings of the new EPM. This allows the user to replace/clone existing drives. If the drive being cloned is of a lower power rating than the original drive and the current settings exceed the max settings of the new drive, then the current settings will default to the max settings.



STOP!

Never install or remove the EPM module while the drive is powered.

Most Lenze-AC Tech products use the EPM for memory storage on the drive. The memory size of the EPM is denoted by its color and drive format structure. The PositionServo drive uses a white EPM module. When the drive is powered up it checks the format style of the EPM in the EPM port. If the EPM Port is empty, or a different color EPM is inserted, the drive will display “-EP-” and no further operation is possible until a white EPM is inserted. If a white EPM with an older format or a new/blank EPM is inserted, the drive will display “FEP?” (format EPM). The drive is asking the user if he wants to reformat the EPM. To reformat the EPM, press the recessed carriage return button [↵] on the front of the drive. If you do not wish to reformat, power down the drive and remove the EPM from the drive.



STOP!

If the EPM contains any data from an existing drive, that data will be overwritten during this procedure. During the reformatting process, some of the data from the internal memory will be written to the EPM and some of the settings will be set to default. Check all parameters.

6.3.3 EPM Fault

If the EPM fails during operation or the EPM is removed from the EPM Port, the drive will generate a fault and display “-EP-”. The fault is logged to the drive's fault history. The fault log will list fault code 38, EPM Failure. Further operation is not possible until the EPM is replaced (inserted) and the drive's power is cycled.



6.4 Configuration of the PositionServo

Regardless of the mode in which the user wishes to operate, he must first configure the PositionServo for his particular motor, mode of operation, and additional features if used. Drive configuration consists of following steps:

- Motor Selection
- Mode of operation selection
- **Reference source selection (Very Important)**
- Drive parameters (i.e. current limit, acceleration / deceleration) setup
- Operational limits (velocity or position limits) setup
- Input / Output (I/O) setup
- Velocity / position compensator (gains) setup (Auto Tuning)
- Optionally store drive settings in a PC file and exit the MotionView program.

To configure drive:

1. Ensure that the control is properly installed and mounted. Refer to section 3 for installation instructions.
2. Perform wiring to the motor and external equipment suitable for desired operating mode and your system requirements.
3. Connect the Ethernet port P2 on the drive to your PC Ethernet port. If connecting directly to the drive from the PC, a crossover cable is required.
4. Make sure that the drive is disabled.
5. Apply power to the drive and wait until "d ,5" shows on the display. For anything other than this, refer to the chart below before proceeding.

Drive Display	Fault	Remedy
-EP-	EPM missing	Insert EPM
FEPF	Format EPM	Reformatting EPM
---	No valid firmware	Update firmware

6. Confirm that the PC and the drive have the correct IP setting. (Section 6.2.2)
7. Launch MotionView software on your computer.
8. From the main toolbar select [Connect].
9. In the Connect dialog box, click [Discover] to ping the network for any drives. If a drive is located the address will appear in the dialog box. If no address appears then you can type the IP address in. The default address for the drive is 192.168.124.120. Click [Connect] to connect to the drive.
10. Once connected, the drive name and identifier are displayed in the upper left-hand corner of the Parameter Tree Window.
11. Select the [Motor] to be used (section 4.5).
12. Click on [Parameters] and set the following:
 [Drive Mode]: Torque, Velocity or Position (Refer to section 6.3.1)
 [Current limit]: enter current limit (in A RMS per phase) i.a.w. the motor.
 [Peak current limit]: peak current limit (in A RMS per phase i.a.w. the motor)
 [Drive PWM frequency]: 8kHz or 16kHz
 Set up additional parameters suitable for the drive mode selected above.
13. After drive is configured, tune the drive if operating in "Velocity", or "Position" mode. "Torque" mode doesn't require additional tuning or calibration. Refer to section 6.8 for details on tuning.



6.5 Position Mode Operation (gearing)

In position mode the drive will follow the master reference signals at the 1-4 inputs of P3. The distance the motor shaft rotates per each master pulse is established by the ratio of the master signal pulses to motor encoder pulses (in single loop configuration). The ratio is set by “System to Master ratio” parameter (see section 5.3.16).

Example 1

Problem: Setup the drive to follow a master encoder output where 1 revolution of the master encoder results in 1 revolution of the motor

Given: Master encoder: 4000 pulses/revolution (post quadrature)
Motor encoder: 8000 pulses/revolution (post quadrature)

Solution: Ratio of System (motor encoder) to Master Encoder is $8000/4000 = 2/1$
Set parameter “System to master ratio” to 2:1

Example 2

Problem: Setup drive so motor can follow a master encoder wheel where 1 revolution of the master encoder results in 3 revolutions of the motor

Given: Motor encoder: 4000 pulses/revolution (post quadrature)
Master encoder: 1000 pulses/revolution (post quadrature).
Desired “gear ratio” is 3:1

Solution: Ratio = (motor encoder PPR / master encoder PPR) x the “gear ratio”:
 $(\text{Motor PPR}/\text{Master PPR}) \times (3/1) \Rightarrow (4000/1000) \times (3/1) \Rightarrow 12/1$
Set parameter “System to master ratio” to 12:1

6.6 Enabling the PositionServo

Regardless of the selected operating mode, the PositionServo must be enabled before it can operate. A voltage in the range of 5-24 VDC connected between P3 pins 26 and 29 (input IN_A3) is used to enable the drive (section 4.1.7, note 3). There is a difference in the behavior of input IN_A3 depending on how the “Enable switch function” is set. **TIP!** If using the onboard +5VDC power supply for this purpose, wire your switch between pins P3.6 and P3.29. Jumper P3.5 to P3.26. If doing this, all inputs in group must be powered by P3.6.

When the “Enable switch function” is set to “RUN”:

IN_A3 acts as positive logic ENABLE or negative logic INHIBIT input depending on:

If user program is not running:	Activating IN_A3 enables the drive
User program running:	Activating IN_A3 acts as negative logic “Inhibit” and operates exactly as if parameter “Enable switch function” set to “Inhibit”

When the “Enable switch function” set to “Inhibit”:

IN_A3 acts as negative logic INHIBIT input regardless of mode or program status.

Activating input IN_A3 doesn’t enables the drive. The drive can be enabled from the user’s program or interface only when IN_A3 is active. Attempt to enable drive by executing the program statement “ENABLE” or from interface will cause the drive to generate a fault, F_36. Regardless of the mode of operation, if the input is deactivated while the drive is enabled, the drive will be disabled and will generate a fault, F_36.



WARNING!

Enabling the drive allows the motor to operate depending on the reference command. Before enabling the drive, make sure that the motor and machine are safe to operate and that moving elements are appropriately guarded.
Failure to comply could result in damage to equipment and/or injury to personnel!



6.7 Drive Tuning

The PositionServo Drive will likely require some tuning of its gains parameters in order to achieve best performance in the application in which it is being applied. Only when the drive is placed in Torque Mode are the gain values not required to be tuned. The table herein lists the gains parameters that should be adjusted for each of the drive operating modes. These parameters are found within the 'Compensation' folder.

MotionView Parameter	Torque Mode	Velocity Mode	Positioning Mode
Velocity P Gain	No	Yes	Yes
Velocity I Gain	No	Yes	Yes
Position P Gain	No	No	Yes
Position I Gain	No	No	Yes
Position D Gain	No	No	Yes
Position I-Limit	No	No	Yes
Gain Scaling	No	Yes	Yes

Before using the tuning procedures detailed in the next sections, ensure that the system is in a safe condition for tuning to be carried out. It is often beneficial to first tune the motor off-load to obtain approximate gains setting before fine tuning in the application.

Check that the drive output to the motor is disabled (via Input A3) and that the drive is powered up. Save any user program code previously entered into the [Indexer Program] folder in MotionView prior to tuning so it can be recalled after tuning is complete.



WARNING!

During both the Velocity and Position tuning procedures the PositionServo drive will perform rotation (motion) of the motor shaft in the forward and reverse directions at velocities based on the user settings. Ensure that the motor and associated mechanics of the system are safe to operate in the way specified during these procedures.

6.7.1 Auto Tuning the Drive

PositionServo drives with hardware revision 2 and higher feature Auto Tuning. To Auto Tune the drive, disable the drive. Ensure that the Indexer program is not running. Select the {Compensation} folder in the navigation tree. De-select [Disable High Performance Mode] and select [Auto Tuning]. The velocity and position loops can be tuned either individually or together.

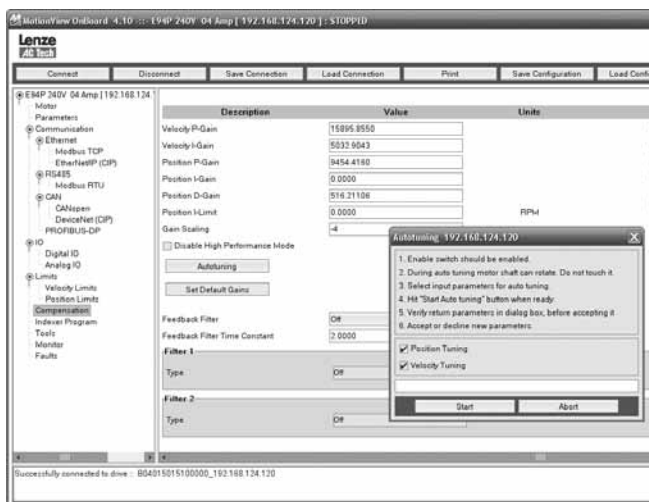



6.7.2 Manually Tuning the Drive in Velocity Mode

The PositionServo drive may also be tuned manually. Follow the procedure in this paragraph to tune the drive in Velocity mode.

1) Parameter Setup

Set up the motor as per the instructions given in the relevant section of this manual. The motor must be configured correctly prior to tuning taking place.

The parameters Drive Mode, Reference and Enable Switch Function are configured automatically by the velocity tuning program. They are not required to be set at this stage.

2) Importing the Velocity Tuning Program

Before importing the Velocity Tuning Program, the example programs must be installed from the Documentation CD that shipped with the drive. If this has not been done then please do so now.

To load the TuneV program file to the drive, select [Indexer Program] in the MotionView Parameter Tree. Select [Import] on main toolbar. Navigate to [C:\Lenze-ACTech\MVOB\Programming_Examples]. If during the installation of the Documentation CD files a different default directory was selected, then navigate to that directory. Click on the [TuneV.txt] file and select [Open].



3) Editing the Velocity Tuning Program

The Tune Velocity Program creates a step velocity demand in the forward and reverse directions that the drive will attempt to follow (based on its velocity gain settings). The drive will run for a set time in the forward direction and then reverse the reference and run for the same set time in the reverse direction, showing the acceleration, deceleration and steady state performance.

The speed and period (time for one complete cycle - forward and reverse) is set in the Indexer program with the following statements:

```

; Motion Parameters
Define SpeedReference 5 ; speed reference in Rps
Define Period 500 ; time in millisec
    
```

Adjust these parameters to values suitable to the application in which the drive is used before going to the next step.



Operation

4) Compile and Download Indexer Program to Drive

In the [Indexer program] folder in MotionView, select the [Load W Source] button on the program toolbar. The TuneV program will be compiled and sent to the drive. Click [Run] on the program toolbar to run the TuneV program. Do NOT enable the drive (via input A3) at this stage.

5) Oscilloscope Settings

Open the [Tools] folder in MotionView and select the [Oscilloscope] tool. Click the [Set on Top] box to place a checkmark in it and keep the scope on top.

In the Scope Tool Window make the following settings:

Channel 1: Signal = "Commanded Velocity"

Scale = appropriate to "SpeedReference" value set in Indexer Program

Channel 2: Signal = "Motor Velocity"

Scale = appropriate to "SpeedReference" value set in Indexer Program

Timebase: = as appropriate to "Period" value of Indexer Program

Trigger: = Channel 1, Rising Edge

Level: = 10 RPM

For better resolution, adjust these scaling factors during the tuning procedure.

6) Compensation Folder

In MotionView, open the [Compensation] folder for the drive. Set [Gain Scaling] to a relatively low value, e.g. -6 for Encoder motor and -8 for a Resolver Motor. Set the [Velocity P-gain] to a mid-value (16000) and set the [Velocity I-Gain] to 0.

7) Gain Tuning

The system should now be ready to start tuning the velocity gains. Start the Oscilloscope by clicking [Run]. Apply the Enable input to Input A3 to enable the drive. At this point of the procedure it is desirable to have little to no motion until we start to increase the gain settings. If the motor vibrates uncontrollably disable the drive, lower the Gain Scaling parameter value and repeat the input enable.

Step 1: Setting the Gain Scaling Parameter

The gain scaling parameter is a 'course adjustment' of the other gain's parameter values. Steadily increase the value of the gain scaling parameter until a reasonable response is obtained from the motor (motor velocity starts to resemble the commanded velocity).

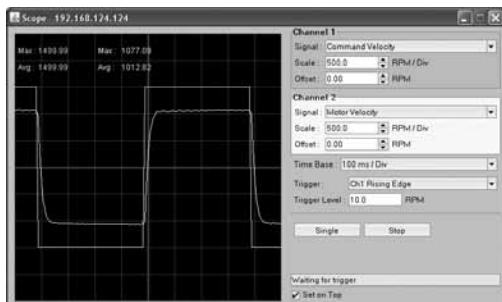

Gain Scaling set too LOW
Motor Velocity significantly different than
Commanded Velocity.

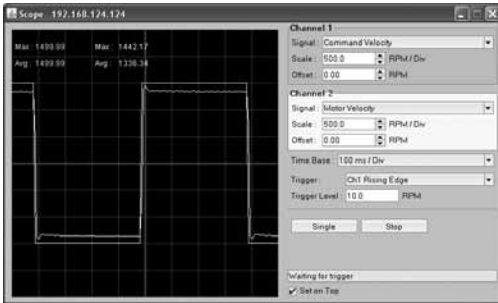

Gain Scaling set OK
Motor Velocity resembles Commanded Velocity. Motor Velocity is reasonably close with a slight overshoot.

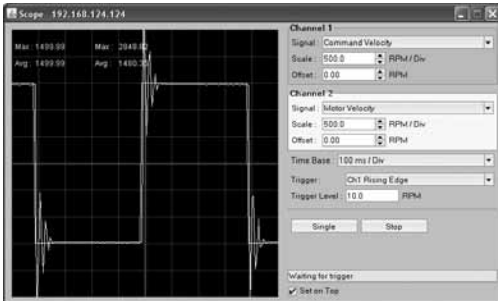

Gain Scaling set too HIGH
Motor Velocity shows significant overshoot following the acceleration periods.

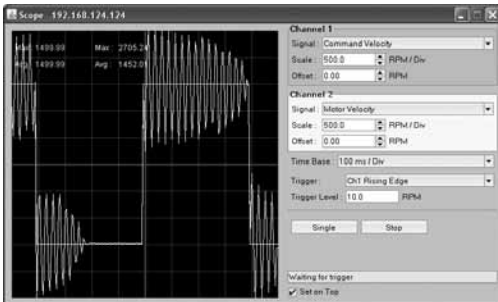

Gain Scaling set significantly too HIGH
Motor Velocity exhibits instability throughout the steady state Commanded Velocity.

Depending on the system being tuned, the motor may go from stable operation (little to no overshoot with stable steady state velocity) to instability (continuous and pronounced oscillations during steady state command) very quickly as gains scaling is increased. The bandwidth for allowing some overshoot with a quick settle time may be very small and may only be achieved through adjustment of the Velocity P-Gain, as described in Step 2. Set the gain scaling parameter to the value preceding that where significant overshoot or continuous instability occurs. With the Gain scaling parameter set move onto tuning the velocity P and I gains.



Operation

Step 2: Fine Tuning the Velocity P-Gain

Slowly alter the Velocity P-Gain (increase and decrease) and observe the motor velocity waveform on the oscilloscope. As the P-Gain increases the gradient of the velocity during acceleration and deceleration will also increase as will the final steady state velocity that is achieved. The application of too much P-Gain will eventually result in an overshoot in the motor velocity, and further increases will result in larger overshooting to the point that instability (continuous oscillation) occurs.

Increase the velocity P-gain until some overshoot occurs. Some overshoot is generally ok, and the objective is typically to achieve the shortest possible settle time (steady state velocity). When the system appears to have reached the shortest possible settle time, with acceptable overshoot, cease from increasing the P-Gain.

Scope traces will be similar to those shown in Step 1, however the P-gain will now be given a more precise adjustment in order to obtain the best possible tuning.

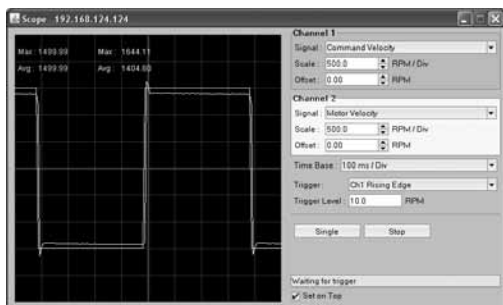

Good Fine Tuning of the P-Gain
Small overshoot with excellent settle time and steady state velocity regulation.

Step 3: Setting the Velocity I-Gain

The purpose of the velocity I-gain is to correct any error that is present between the commanded velocity and the steady state velocity that could not be rectified by adjustment of the velocity P-gain. Adjustment of the velocity I-gain can also reduce the steady state ripple that may occur in the velocity waveform. Lastly, velocity I-gain has a positive effect on the holding torque produced by the motor.

Slowly increase the “Velocity I-Gain” and check for correction of the steady state error in the velocity waveform. Continuing to increase the velocity I-gain will eventually result in increased overshoot and instability in the motor velocity waveform. Stop increasing the I-Gain when additional overshoot or instability starts to occur.

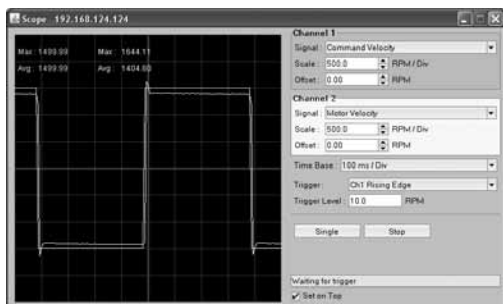

I-Gain set to LOW
Error exists between Commanded steady state velocity and Actual steady state velocity

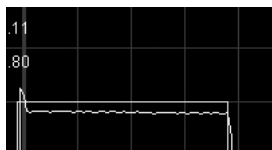

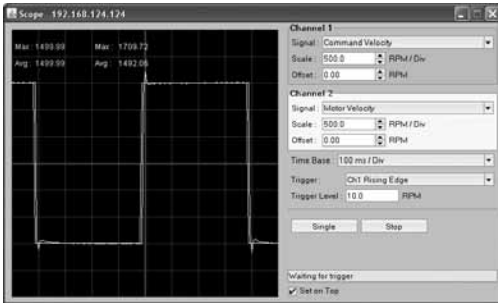

I-Gain set OK
No error between Commanded steady state velocity and Actual steady state velocity with excellent stability.

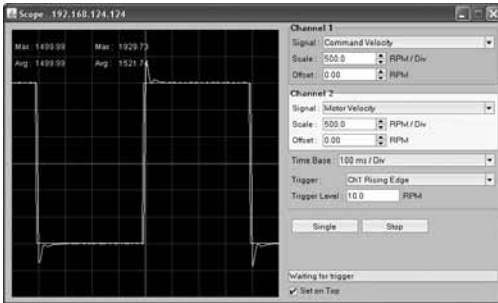
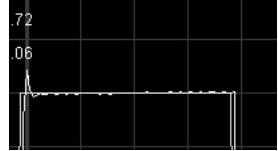

I-Gain set too HIGH
Additional overshoot and oscillations are starting to occur. Steady state velocity regulation

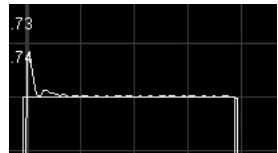

Step 4: Check Motor Currents

Finally check the motor currents on the Oscilloscope. Make the following settings to the oscilloscope.

Channel 1:

Signal = "Phase Current RMS"

Scale = as appropriate to peak current limit set in drive parameters (MotionView)

Timebase: = as appropriate to "Period" value of Indexer Program

Trigger: = Channel 2, Rising Edge

Level: = 10 RPM

Observe the waveforms to insure there are no significant oscillations. Reduce the gains values if necessary.

The current waveform should be showing spikes of current during acceleration / deceleration and steady state current during any steady state velocity. The maximum value (peak value) of the current waveform is shown at the top of the oscilloscope screen. This maximum value can be compared to the drive nominal current and peak current settings to check how much of the motors potential performance is being used and if optimum performance is being achieved.



Operation

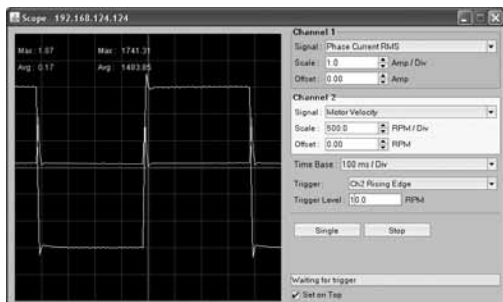

Good Current Trace
Uniform current pulses during accel/
deceleration and stable current during steady
state velocity.



Max : 1.87
Avg : 0.17

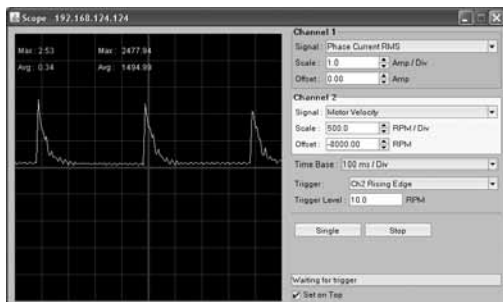

Instability in Drive Output Current
(Note: Channel 2 trace has been removed for
clarity).

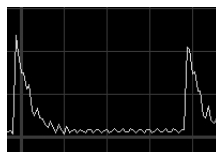

8) End Velocity Tuning

Remove the Enable Input from input A3 (disable the drive). In MotionView, click on the [Indexer] folder for the drive. Click [Reset] on the program toolbar. If the drive is to be run in just velocity mode then tuning is now complete. If the drive is to be used in Positioning mode continue with 'Tuning the Drive in Position Mode', section 6.8.3.

6.7.3 Manually Tuning the Drive in Position Mode

The Position Loop can also be manually tuned. Manual Velocity Tuning should be carried out prior to the manual tuning of the position loop. Refer to the Velocity Tuning section, 6.7.2.

1) Parameter Set up

In MotionView, open the [Limits] folder and then the [Position Limits] sub-folder. Set the [Position Error] and [Max Error Time] parameters to their maximum values to effectively disable the position error trip while tuning takes place. Ensure the system is safe to operate in this manner.

Position Error = 32767

Max Error Time = 8000

The Drive Mode, Reference and Enable Switch Function parameters are automatically configured by the velocity tuning program. They do not require setting at this stage.



2) Importing the Position Tuning Program

Before importing the Position Tuning Program, the example programs must be installed from the Documentation CD that shipped with the drive. If this has not been done then please do so now.

To load the TuneP program file to the drive, select [Indexer Program] in MotionView. Select [Import] on main toolbar. Navigate to [C:\Lenze-ACTech\MVOB\Programming_Examples]. If during the installation of the Documentation CD files a different default directory was selected, then navigate to that directory. Click on the [TuneP.txt] file and select [Open].



3) Editing the Position Tuning Program

The Tune Position Program performs trapezoidal moves in the forward and reverse direction separated by a defined pause (or time delay).

The Accel, Decel, and MaxV variables within the TuneP program define the ramps and steady state velocity that will be used to execute the motion commands.

ACCEL = 500	;500 rps*s	Accel = Acceleration speed
DECEL = 500	;500 rps*s	Decel = Deceleration speed
MAXV = 20	;20 Rps	MaxV = Maximum

The size of each move and the pause between the moves is defined in the following lines of code. There are two moves and pauses for the forward and reverse moves to be performed.

MOVED 0.25	;move 1 rev	MoveD = Move distance
wait time 200	;wait time to analyze 'standstill' stability	wait time = Delay period
MOVED -0.25	;move opposite direction 1 rev	
wait time 200	;wait time to analyze 'standstill' stability	

Adjust these parameters if required to best suit the application before going to the next step.

4) Compile and Download Indexer Program to Drive

In the [Indexer Program] folder in MotionView, select the [Load W Source] button at the program toolbar. The TuneP program will be compiled and sent to the drive. Click [Run] on the program toolbar to run the TuneP program. Do NOT enable the drive (via input A3) at this stage.



Operation

5) Oscilloscope Settings

Open the [Tools] folder in MotionView and select the [Oscilloscope] tool. Click the [Set on Top] box to place a checkmark in it and keep the scope on top.

In the Scope Tool Window, make the following settings:

Channel 1:

Signal = "Position Error"

Scale = as appropriate to the Error that results once the TuneP program is run.

Channel 2:

Signal = "Target Position"

Scale = as appropriate to the position move generated by the TuneP program

Timebase: = as appropriate to the "Period" of the moves being generated.

Trigger: = Channel 1, Rising Edge.

Level: = 10 Pulses

6) Compensation Folder

Open the [Compensation] folder in MotionView.

Leave the Velocity P-Gain and Velocity I Gain unchanged, as they should already have been setup during velocity tuning. Do not adjust the Gain Scaling Parameter during this procedure.

Set the [Position P-gain] to a low value (e.g. 100) and set the [Position I-Gain] and [Position D-Gain] to 0.

7) Gain Tuning

The system should now be ready to start tuning the position loop. Start the Oscilloscope by clicking [Run]. Apply the Enable input A3 to enable the drive.

The general goal in tuning the position loop is to achieve the minimum position error while maintaining system stability. Some experimentation with gain values will be required to achieve the best performance for the application.

Step 1: Setting the Position P-Gain

Slowly increase the Position P-Gain while watching the position error waveform on oscilloscope Channel 1. It is important to watch both the Max Error as well as the Average Error. While increasing Position P-gain, it should be apparent that both the Max Error as well as the Average Error decrease.

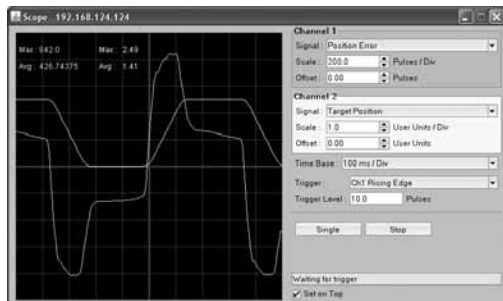

Position P-Gain set too LOW
Large Position Error occurring and large error
in final positioning achieved



Increased Position P-Gain
Shows improvement to the maximum error
and the final positioning accuracy

At some point while increasing the P-Gain, additional oscillations (Average Error) will start to appear on the position error waveform.



Further Increased Position P-Gain
Shows very good reduction to the maximum
error but with additional oscillations starting
to occur.

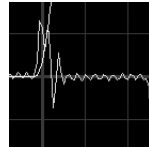

Step 2: Setting the Position D-Gain

Slowly increase the D-Gain while watching the position error waveform on oscilloscope Channel 1. As the D-Gain is increased, the position error oscillation caused by the P-Gain, should start to decrease. Continue to increase the D-Gain until oscillation is gone or until D-Gain is no longer having any apparent effect.



Adjustment of Position D-Gain
in conjunction with the P-Gain dampens
out additional oscillations while improving
position error.

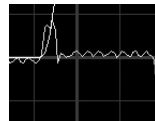

For optimum tuning, it is sometimes required to repeat the process of increasing the P-Gain until a slight oscillation occurs and then increase the D-Gain to suppress that oscillation. This procedure can be repeated until the increasing of D-Gain has negligible effect on the position error waveform.



Operation

Step 3: Setting the Position I-Gain and Position I-Gain Limit

The objective here is to minimize the position error during steady state operation and improve positioning accuracy. Start to increase the Position I-gain. Increasing the I-gain will increase the drive's reaction time while the I-Limit will set the maximum influence that the I-Gain can have on the Integral loop. When adjusting the I-gain start with a very small value for the I-gain (e.g. 1) then increase the I-gain parameter value until standstill error is compensated and positioning accuracy is satisfactory. Remember that large values of Position I-limit can cause a large instability in the control loop and unsettled oscillation of the system mechanics.



Position Error trace following the tuning of Position P-, I- and D-Gains

Step 4: Check Motor Currents

Set the oscilloscope channel 2 to 'Phase Current RMS'

Channel 2:

Signal = "Phase Current RMS"

Scale = as appropriate to peak current limit set in drive parameters (MotionView)

Timebase: = as appropriate to the "Period" of the moves being generated

Trigger: = Ch1 Rising Edge

Level: = 10 Pulses

Observe the Current waveform to make sure that there are no significant oscillations during the steady state sections of the position profile (times when target position is not changing). If so then decrease the gains values until the oscillations are either removed or reduced to an acceptable level.



Minimal oscillation when motor positioned to target position.





8) Setting the Position Error Limits

Look at the position error waveform on the oscilloscope. Note the maximum time that position errors exist (from the time axis of the scope) and the maximum peak errors being seen (from the value at the top of the screen). Use these values to set the position error limits to provide suitable position error protection for the application.

Open the 'Limits' folder and 'Position Limits' sub-folder within the MotionView node tree and set suitable values for the 'Position Error' and 'Max Error Time' parameters.



Maximum error and time period for error existing.

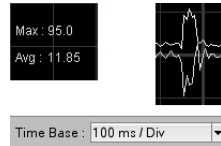

In this particular example maximum error in pulses is 95.0. The time this peak error occurs can be read from the oscilloscope at approximately $\frac{1}{2}$ of a division with each division equal to 100ms, hence the error pulse lasts approximately 50ms. Suitable settings for position error within this application might be as follows, although looser or tighter limits could be applied depending on the requirements of the application.

Description	Value
Position Error	100
Max Error Time	50

9) End Tuning

Remove the Enable Input from input A3 (disable the drive).

Click on the [Indexer Program] folder in MotionView. Click the [Reset] button at the top of the indexer programming screen.

Tuning is now complete.



6.8 Upgrading Firmware

Starting with hardware revision 2 and higher, MotionView OnBoard (MVOB) features an [Upgrade] action button located in the top right-hand corner. The [Upgrade] selection launches a firmware loading utility to easily upgrade the drive's firmware revision. Browse to the firmware ".lar" file on your local PC and follow the prompts.

After upgrading the firmware re-download MVOB from the drive as the firmware may contain a newer version. If the drive displays "FEP?", the new firmware contains additional parameter data from the previously installed firmware. Press and hold the drive's [-->] button until the drive display reads "bUSY". Release the button and the drive will format the EPM to the new firmware revision.

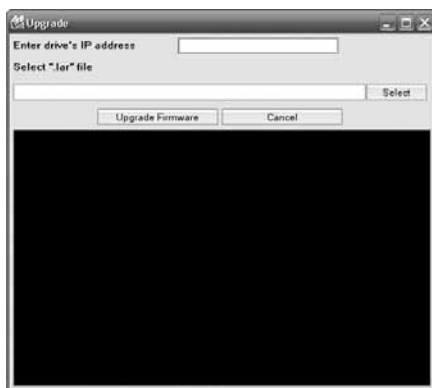

Upgrade Pop-up Window



7 Quick Start Reference

This section provides instructions for External Control, Minimum Connections and Parameter Settings to quickly setup a PositionServo drive for External Torque, Velocity or Positioning Modes. The sections are NOT a substitute for reading the entire PositionServo User Manual. Observe all safety notices in this manual.

7.1 Quick Start - External Torque Mode

Mandatory Signals:

These signals are required in order to achieve motion from the motor.

Connector - Pin	Input Name	Description
P3-22	ACOM	Analog Common Reference from Controller
P3-24	AIN1+	Analog Torque Reference from Controller – Positive
P3-25	AIN1-	Analog Torque Reference from Controller – Negative
P3-26	IN_A_COM	Common Input for Enable Input
P3-29	IN_A3	Enable Input to Controller or switch

Optional Signals:

These signals may be required dependant on the control system being implemented.

Connector - Pin	Input Name	Description
P3-6	+5V	+5V Output for Enable Input (If required)
P3-7	A+	Buffered Encoder Output
P3-8	A-	Buffered Encoder Output
P3-9	B+	Buffered Encoder Output
P3-10	B-	Buffered Encoder Output
P3-11	Z+	Buffered Encoder Output
P3-12	Z=	Buffered Encoder Output
P3-23	AO	Analog Output
P3-41	RDY+	Ready output Collector
P3-42	RDY-	Ready output Emitter
P3-43	OUT1-C	Programmable output #1 Collector
P3-44	OUT1-E	Programmable output #1 Emitter
P3-45	OUT2-C	Programmable output #2 Collector
P3-46	OUT2-E	Programmable output #1 Emitter
P3-47	OUT3-C	Programmable output #3 Collector
P3-48	OUT3-E	Programmable output #1 Emitter
P3-49	OUT4-C	Programmable output #4 Collector
P3-50	OUT4-E	Programmable output #1 Emitter

Mandatory Parameter Settings:

These Parameters are required to be set prior to running the drive

Folder / Sub-Folder	Parameter Name	Description
Parameters	Drive Mode	Set to [Torque]
	Reference	Set to [External]
IO / Analog IO	Analog Input (Current Scale)	Set to required current per 1V input from controller
	Analog Input Dead band	Set zero torque Dead band in mV
	Analog Input Offset	Set Analog Offset for Torque Reference
IO / Digital IO	Enable Switch Function	Set to [Run]



Quick Start Reference

Optional Parameter Settings:

These parameters may require setting depending on the control system implemented.

Folder / Sub-Folder	Parameter Name	Description
Parameters	Resolver Track	PPR for simulated encoder on 941 Resolver drive
IO / Digital IO	Output 1 Function	Set to any pre-defined function required
	Output 2 Function	Set to any pre-defined function required
	Output 3 Function	Set to any pre-defined function required
	Output 4 Function	Set to any pre-defined function required
IO / Analog IO	Adjust Analog Input	Tool that can be used to learn analog input level
	Analog Output	Set to any pre-defined function required
	Analog Output Current Scale	Set to scale analog output if current value is selected
	Analog Output Velocity Scale	Set to scale analog output if velocity value is selected
Limits / Velocity Limits	Zero Speed	Set bandwidth for activation of a Zero Speed Output
	At Speed	Set Target Speed for activation of a At Speed Output
	Speed Window	Set bandwidth for activation of a At Speed Output

7.2 Quick Start - External Velocity Mode

Mandatory Signals:

These signals are required in order to achieve motion from the motor.

Connector - Pin	Input Name	Description
P3-22	ACOM	Analog Common Reference from Controller
P3-24	AIN1+	Analog Velocity Reference from Controller – Positive
P3-25	AIN1-	Analog Velocity Reference from Controller – Negative
P3-26	IN_A_COM	Common Input for Enable Input
P3-29	IN_A3	Enable Input to Controller or switch

Optional Signals:

These signals may be required dependant on the control system being implemented.

Connector - Pin	Input Name	Description
P3-6	+5V	+5V Output for Enable Input (If required)
P3-7	A+	Buffered Encoder Output
P3-8	A-	Buffered Encoder Output
P3-9	B+	Buffered Encoder Output
P3-10	B-	Buffered Encoder Output
P3-11	Z+	Buffered Encoder Output
P3-12	Z=	Buffered Encoder Output
P3-23	A0	Analog Output
P3-41	RDY+	Ready output Collector
P3-42	RDY-	Ready output Emitter
P3-43	OUT1-C	Programmable output #1 Collector
P3-44	OUT1-E	Programmable output #1 Emitter
P3-45	OUT2-C	Programmable output #2 Collector
P3-46	OUT2-E	Programmable output #1 Emitter
P3-47	OUT3-C	Programmable output #3 Collector
P3-48	OUT3-E	Programmable output #1 Emitter
P3-49	OUT4-C	Programmable output #4 Collector
P3-50	OUT4-E	Programmable output #1 Emitter



Mandatory Parameter Settings:

These parameters are required to be set prior to running the drive.

Folder / Sub-Folder	Parameter Name	Description
Parameters	Drive Mode	Set to [Velocity]
	Reference	Set to [External]
	Enable Velocity Accel / Decel Limits	Enable Ramp rates for Velocity Mode
	Velocity Accel Limit	Set required Acceleration Limit for Velocity command
	Velocity Decel Limit	Set required Deceleration Limit for Velocity command
IO / Analog IO	Analog Input (Velocity Scale)	Set to required velocity per 1 volt input from controller
	Analog Input Dead band	Set zero velocity Dead band in mV
	Analog Input Offset	Set Analog Offset for velocity Reference
IO / Digital IO	Enable Switch Function	Set to [Run]
Compensation (see tuning section)	Velocity P-Gain	Set P-Gain for Velocity loop
	Velocity L-Gain	Set I-Gain for Velocity loop
	Gain Scaling	Set Gain Scaling Parameter

Optional Parameter Settings:

These parameters may require setting depending on the control system implemented.

Folder / Sub-Folder	Parameter Name	Description
Parameters	Resolver Track	PPR for simulated encoder on 941 Resolver drive
IO / Digital IO	Output 1 Function	Set to any pre-defined function required
	Output 2 Function	Set to any pre-defined function required
	Output 3 Function	Set to any pre-defined function required
	Output 4 Function	Set to any pre-defined function required
IO / Analog IO	Adjust Analog Input	Tool that can be used to learn analog input level
	Analog Output	Set to any pre-defined function required
	Analog Output Current Scale	Set to scale analog output if current value is selected
	Analog Output Velocity Scale	Set to scale analog output if velocity value is selected
Limits / Velocity Limits	Zero Speed	Set bandwidth for activation of Zero Speed Output
	At Speed	Set Target Speed for activation of At Speed Output
	Speed Window	Set bandwidth for activation of At Speed Output



7.3 Quick Start - External Positioning Mode

Mandatory Signals:

These signals are required in order to achieve motion from the motor.

Connector-Pin	Input Name	Description
P3-1	MA+	Position Reference Input for Master Encoder / Step-Direction Input
P3-2	MA-	Position Reference Input for Master Encoder / Step-Direction Input
P3-3	MB+	Position Reference Input for Master Encoder / Step-Direction Input
P3-4	MB-	Position Reference Input for Master Encoder / Step-Direction Input
P3-26	IN_A_COM	Common Input for Enable Input
P3-29	IN_A3	Enable Input to Controller or switch

Optional Signals:

These signals may be required dependant on the control system being implemented.

Connector - Pin	Input Name	Description
P3-6	+5V	+5V Output for Enable Input (If required)
P3-7	A+	Buffered Encoder Output
P3-8	A-	Buffered Encoder Output
P3-9	B+	Buffered Encoder Output
P3-10	B-	Buffered Encoder Output
P3-11	Z+	Buffered Encoder Output
P3-12	Z=	Buffered Encoder Output
P3-22	ACOM	Analog Common Reference from Controller
P3-23	A0	Analog Output
P3-27	IN_A1	Positive Limit Switch: Required if Limit Switch Function is used
P3-28	IN_A2	Negative Limit Switch: Required if Limit Switch Function is used
P3-41	RDY+	Ready output Collector
P3-42	RDY-	Ready output Emitter
P3-43	OUT1-C	Programmable output #1 Collector
P3-44	OUT1-E	Programmable output #1 Emitter
P3-45	OUT2-C	Programmable output #2 Collector
P3-46	OUT2-E	Programmable output #1 Emitter
P3-47	OUT3-C	Programmable output #3 Collector
P3-48	OUT3-E	Programmable output #1 Emitter
P3-49	OUT4-C	Programmable output #4 Collector
P3-50	OUT4-E	Programmable output #1 Emitter



Mandatory Parameter Settings:

These parameters are required to be set prior to running the drive

Folder / Sub-Folder	Parameter Name	Description
Parameters	Drive Mode	Set to [Position]
	Reference	Set to [External]
	Step Input Type	Set to [S/D] or [Master Encoder]. (S/D = Step + Direction)
	System to Master Ratio	Set 'Master' and 'Slave' values to gear position input pulses to pulse revolution of the motor shaft
IO / Digital IO	Enable Switch Function	Set to [Run]
Limits / Position Limits	Position Error	Set Position Error Limit specific to application
	Max Error Time	Set Position Error Time specific to application
Compensation (see tuning section)	Velocity P-Gain	Set P-Gain for Velocity loop
	Velocity I_Gain	Set I-Gain for Velocity loop
	Position P-Gain	Set P-Gain for Position Loop
	Position I-Gain	Set I-Gain for Position Loop
	Position D-Gain	Set D-Gain for Position Loop
	Position I-Limit	Set I-Limit for Position Loop
	Gain Scaling	Set Gain Scaling Parameter

Optional Parameter Settings:

These parameters may require setting depending on the control system implemented.

Folder / Sub-Folder	Parameter Name	Description
Parameters	Resolver Track	PPR for simulated encoder on 941 Resolver drive
IO / Digital IO	Output 1 Function	Set to any pre-defined function required
	Output 2 Function	Set to any pre-defined function required
	Output 3 Function	Set to any pre-defined function required
	Output 4 Function	Set to any pre-defined function required
	Hard Limit Switch Actions	Set if Hard Limit Switches used in Application
IO / Analog IO	Adjust Analog Input	Tool that can be used to learn analog input level
	Analog Output	Set to any pre-defined function required
	Analog Output Current Scale	Set to scale analog output if current value is selected
	Analog Output Velocity Scale	Set to scale analog output if velocity value is selected
Limits / Velocity Limits	Zero Speed	Set bandwidth for activation of a Zero Speed Output
	At Speed	Set Target Speed for activation of a At Speed Output
	Speed Window	Set bandwidth for activation of a At Speed Output



8 Diagnostics

8.1 Diagnostic Display

Apply power to the drive and wait until “d ,5” shows on the display. For anything other than “d ,5”, refer to the chart below before proceeding.

Drive Display	Fault	Remedy
-EP-	EPM missing	Insert EPM
FEP	Format EPM	Reformatting EPM
---	No valid firmware	Update firmware

PositionServo drives are equipped with a diagnostic LED display and three push buttons to select diagnostic information and to edit a limited set of parameter values.

Parameters can be scrolled by using the “UP” and “DOWN” (▲▼) buttons. To view a value, press “Enter”(↵). To return back to scroll mode press “Enter” again. After pressing the “Enter” button on editable parameters, the yellow LED “C” will blink indicating that parameter value can be changed. Use “UP” and “DOWN” buttons to change the value. Press “Enter” to store new setting and return back to scroll mode.

Display	Description
StRt	current drive status - (↵) to view: rUn - drive running d ,5 - drive disabled F_XX - drive fault. Where XX is the fault code (section 8.4.1)
Hx.xx	Hardware revision (e.g. H2.00)
Fx.xx	Firmware revision (e.g. F2.06)
bRud	RS232/RS485(normal mode) baud rate - (↵) to set ▲▼ selects from 2400 to 115200 baudrates
Rdr	Drive's address - (↵) to set ▲▼ sets 0 - 31 drive's address
Ft5	Stored fault's history - (↵) to view ▲▼ scroll through stored faults F0XX - F7XX, “XX” is the fault code (section 8.4.1)
Ht	Heatsink temperature - (↵) to view Shows heatsink temperature in °C if greater than 40°C. Otherwise shows “LO” (low).
EnC	Encoder activity - (↵) to view Shows primary encoder counts for encoder diagnostics activity
HL	Displays motor's hall sensor states - (↵) to view Shows motor hall states in form XXX , where X is 1 or 0 - sensor logic states.
boE	0 = Autoboot disabled 1 = Autoboot enabled (Feature available in FW 3.50 or higher)
bU	Displays drive DC bus voltage - (↵) to view Shows DC bus voltage value
Urr	Displays motor's phase current (RMS) Shows current value if drive is enabled, otherwise shows “d ,5”
Rnb	CAN Baudrate
RnR	CAN Address
Rno	CAN Operational Mode
Rnd	CAN Delay
RnE	CAN Enable/disable



Display	Description
dHCP	Ethernet DHCP Configuration: 0="dHCP" is disabled; 1="dHCP is enabled.
i P_4	IP Address Octet 4
i P_3	IP Address Octet 3
i P_2	IP Address Octet 2
i P_1	IP Address Octet 1
Ptc	Displays the motor ptc resistance in ohms
R in 1	Displays the voltage on Drive Analog Input 1 (Ain1)
R in 2	Displays the voltage on Drive Analog Input 2 (Ain2)

8.2 Diagnostic LEDs

The PositionServo has five diagnostic LEDs located around the periphery of the front panel display as shown in the drawing below. These LEDs are designed to help monitor system status and activity as well as troubleshoot any faults.

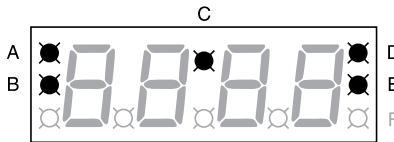

S913

LED	Function	Description
A	Enable	Orange LED indicates that the drive is ENABLED (running).
B	Regen	Yellow LED indicates the drive is in regeneration mode.
C	Data Entry	Yellow LED will flash when changing.
D	Comm Fault	Red LED illuminates upon a communication fault. (in CANbus only)
E	Comm Activity	Green LED flashes to indicate communication activity.

8.3 Stop/Reset

With hardware version 2 and higher, MotionView OnBoard (MVOB) features a [Stop/Reset] action button in the top right-hand corner. Pressing the red [Stop/Reset] button causes all motion to stop and resets the drive.



Stop/Reset Button



8.4 Faults

8.4.1 Fault Codes

Faults in the drive are immediately shown on the drive display. The fault condition is also recorded to the drive trip log and the DFaults register inside the drive. The various trip conditions, as they appear on the display of the drive are listed in the table below.

Fault Codes as Displayed on the Drive

Fault Code (Display)	Fault	Description
F_0U	Over voltage	Drive bus voltage reached the maximum level, typically due to motor regeneration
F_Fb	Feedback error	Invalid Hall sensors code; Resolver signal lost or at least one motor hall sensor is inoperable or not connected.
F_0C	Over current	Drive exceeded peak current limit. Software incapable of regulating current within 15% for more than 20mS. Usually results in wrong motor data or poor tuning.
F_0t	Over temperature	Drive heatsink temperature has reached maximum rating. Trip Point = 100°C for all drives except 480V 6A & 9A drives Trip Point = 108°C for 480V 6A & 9A drives
F_EF	ISO13849-1 fault	The drive is disabled by the ISO13849-1 Safety Function
F_0S	Over speed	Motor has reached velocity above its specified limit
F_PE	Position Error Excess	Position error has exceeded maximum value.
F_bd	Bad motor data	Motor profile data is invalid or no motor is selected.
F_EP	EPM failure	EPM failure on power up
-EP-	EPM missing	EPM not recognized (connected) on power up
F_09	Motor over temperature	Motor over temperature switch activated; Optional motor temperature sensor (PTC) indicates that the motor windings have reached maximum temperature
F_10	Subprocessor failure	Error in data exchange between processors. Usually occurs when EMI level is high due to poor shielding and grounding.
F_14	Under voltage	(Applies to drive's with hardware version 1). Occurs when the bus voltage level drops below 50% of nominal bus voltage while drive is operating. An attempt to enable the drive with low bus voltage will also result in this fault.
F_15	Hardware overload protection	Occurs when the phase current becomes higher than 400% of total drive's current capability for more then 5µs.
F_18	Arithmetic Error Division by zero	Statement executed within the Indexer Program results in a division by 0 being performed. Drive programming error (error in drive source code).
F_19	Arithmetic Error Register overflow	Statement executed within the Indexer Program results in a value being generated that is too big to be stored in the requested register. Drive programming error (error in drive source code).
F_20	Subroutine stack overflow	Exceeded 32 levels subroutines stack depth. Caused by executing excessive subroutine calls without a RETURN statement. Drive programming error (error in drive source code).
F_21	Subroutine stack underflow	Executing RETURN statement without preceding call to subroutine. Drive programming error (error in drive source code).
F_22	Arithmetic stack overflow	Variable evaluation stack overflow. Expression too complicated for compiler to process. Drive programming error (error in drive source code).
F_23	Motion Queue overflow	32 levels depth exceeded. Drive programming error (in drive source code).
F_24	Motion Queue underflow	Relates to the MDV statements in the Indexer Program. Drive programming error (error in drive source code).
F_25	Unknown opcode	Byte code interpreter error; May occur when program is missing the closing END statement; when subroutine has no RETURN statement; or if data in EPM is corrupted at run-time



Fault Code (Display)	Fault	Description
F_26	Unknown byte code	Byte code interpreter error; May occur when program is missing the closing END statement; when subroutine has no RETURN statement; or if data in EPM is corrupted at run-time
F_27	Drive disabled	Attempt to execute motion while drive is disabled. Drive programming error (error in drive source code).
F_28	Accel too high	Motion statement parameters calculate an Accel value above the system capability. Drive programming error (error in drive source code).
F_29	Accel too low	Motion statement parameters calculate an Accel value below the system capability. Drive programming error (error in drive source code).
F_30	Velocity too high	Motion statement parameters calculate a velocity above the system capability. Drive programming error (error in drive source code).
F_31	Velocity too low	Motion statement parameters calculate a velocity below the system capability. Drive programming error (error in drive source code).
F_32	Positive Limit Switch	Positive limit switch is activated. (Only available while drive is in position mode)
F_33	Negative Limit Switch	Negative limit switch is activated. (Only available while drive is in position mode)
F_34	Positive motion w/ Pos Lim Sw ON	Attempt at positive motion with engaged positive limit switch
F_35	Negative motion w/ Neg Lim Sw ON	Attempt at negative motion with engaged negative limit switch
F_36	Drive Disabled by User at Enable Input	The drive is disabled while operating or an attempt is made to enable the drive without deactivating "Inhibit input". "Inhibit" input has reverse polarity
F_37	Under voltage	(Applies to drive's with hardware version 2 and higher). Occurs when the bus voltage level drops below 50% of nominal bus voltage while drive is operating. An attempt to enable the drive with low bus voltage will also result in this fault.
F_39	Positive soft limit reached	Programmed (Soft) absolute limits reached during motion
F_40	Negative soft limit reached	Programmed (Soft) absolute limits reached during motion
F_41	Unknown Variable ID	Attempt to use variable with unknown ID from user program. Drive programming error (error in drive source code).
F_45	2nd Encoder Position Error	Secondary encoder position error limit has exceeded maximum value (applies to hardware version 1)
F_49	Illegal manipulation of APOS	The APOS variable cannot be manipulated while a MOVE is being executed

8.4.2 Fault Event

When the drive encounters any fault, the following events occur:

- Drive is disabled
- Internal status is set to "Fault"
- Fault number is logged in the drive's internal memory for later interrogation
- Digital output(s), if configured for "Run Time Fault", are asserted
- Digital output(s), if configured for READY, are de-asserted
- If the display is in the default status mode, the LEDs display F0XX where XX is current fault code.
- "Enable" LED turns OFF



8.4.3 Fault Reset

Fault reset is accomplished by disabling or re-enabling the drive depending on the setting of the [Fault Reset] parameter (section 5.3.8).

If [On Disable] is selected, the fault is cleared when the drive is disabled.

If [On Enable] is selected, the fault is cleared when the drive is re-enabled.

8.4 Troubleshooting



DANGER!

Hazard of electrical shock! Circuit potentials are up to 480 VAC above earth ground. Avoid direct contact with the printed circuit board or with circuit elements to prevent the risk of serious injury or fatality. Disconnect incoming power and wait at least 60 seconds before servicing drive. Capacitors retain charge after power is removed.

Before troubleshooting

Perform the following steps before starting any procedure in this section:

- Disconnect AC or DC voltage input from the PositionServo. Wait at least 60 seconds for the power to discharge.
- Check the PositionServo closely for damaged components.
- Check that no foreign material has fallen or become lodged in the PositionServo.
- Verify that every connection is correct and in good condition.
- Verify that there are no short circuits or grounded connections.
- Check that the drive's rated phase current and RMS voltage are consistent with the motor ratings.

For additional assistance, contact your local PositionServo authorized distributor.

Problem	External line fuse blows
Possible Cause	Line fuses are the wrong size Motor leads or incoming power leads are shorted to ground. <i>Nuisance tripping caused by EMI noise spikes caused by poor grounding and/or shielding.</i>
Suggested Solution	<ul style="list-style-type: none"> • Check that line fuses are properly sized for the motor being used. • Check motor cable and incoming power for shorts. • Check that you follow recommendation for shielding and grounding listed in section "shielding and grounding" early in this manual.

Problem	Ready LED is on but motor does not run.
Suggested Solution	<p>If in Torque or Velocity mode: Reference voltage input signal is not applied. Reference signal is not connected to the PositionServo input properly; connections are open. In MotionView program check <Parameters> <Reference> set to <External></p> <p>For Velocity mode only: In MotionView check <Parameters> <Compensation><Velocity loop filter> P-gain must be set to value more then 0 in order to run. Without load motor will run with P-gain set as low as 20 but under load might not. If P-gain is set to 0 motor will not run at all.</p> <p>In Position mode with master encoder motion source (no program) Reference voltage input signal source is not properly selected. In MotionView program check <Parameters> <Reference> set to <External></p> <p>In Position mode using indexing program Variables ACCEL, DECEL,MAXV, UNITS are not set or set to 0. Before attempting the move set values of motion parameters ACCEL, DECEL,MAXV, UNITS</p>



Problem	In velocity mode, the motor runs away.
Possible Cause	<ul style="list-style-type: none"> • Hall sensors or encoder mis-wired. • PositionServo not programmed for motor connected.
Suggested Solution	<ul style="list-style-type: none"> • Check Hall sensor and encoder connections. • Check that the proper motor is selected.
Problem	Cannot connect second drive when sequentially connecting 2 Ethernet-based Drives
Possible Cause	If when trying to sequentially commission several Ethernet-based drives with the same PC, MotionView discovers the IP address, but then reports that the drive cannot be connected. Due to the fact that the PS drives are shipped with the same factory default IP address.
Suggested Solution	<p>After the first drive is connected, open the Command window on your PC and run the command "arp -d" just before connecting MotionView to another drive.</p>  <pre> C:\WINDOWS\system32\cmd.exe Microsoft Windows [Version 5.1.2600] (C) Copyright 1985-2001 Microsoft Corp. C:\Documents and Settings\uchen>arp -d C:\Documents and Settings\uchen> </pre> <p>ARP is the Address Resolution Protocol. Each PositionServo drive has two addresses, one MAC address and one IP address. ARP links these two addresses together. Each PositionServo drive has the same factory default IP address, but a different MAC address. After connecting the first drive, the Ethernet hub will cache its IP and MAC address for about 2 minutes. When another drive with the same IP address and different MAC address is connected to the network, ARP will observe the mismatching between the IP address and MAC address.</p>

Notes

Notes

Lenze AC Tech Corporation
630 Douglas Street • Uxbridge, MA 01569 • USA
Sales: (800) 217-9100 • Service (508) 278 9100
www.lenzeamericas.com

S94H201A